



INSTR 20060253155  
OR BK 08594 PG 3449 PGS=121  
MARTHA G. HAYNIE, COMPTROLLER  
ORANGE COUNTY, FL  
04/18/2006 02:33:33 PM  
REC FEE 1,030.00

This instrument prepared by, or under the supervision of (and after recording, return to):

Brian J. Sherr, Esq.  
Greenberg Traurig, P.A.  
401 E. Las Olas Blvd., Suite 2000  
Fort Lauderdale, FL 33301

**DECLARATION  
OF  
THE FOUNTAINS AT METRO WEST, A CONDOMINIUM**

**Birkat Raphael 1, LLC, a Delaware limited liability company, hereby declares:**

1. Introduction and Submission.

- 1.1 The Land. The Developer (as hereinafter defined) owns the fee title to certain land located in Orange County, Florida, as more particularly described in **Exhibit "1"** attached hereto (the "Land").
- 1.2 Submission Statement. Except as set forth in this Subsection 1.2, the Developer hereby submits the Land and all improvements erected or to be erected thereon, and all other property, real, personal or mixed, now or hereafter situated on or within the Land - but excluding all public or private (e.g. cable television and/or other receiving or transmitting lines, fiber, antennae or equipment) utility installations and all leased property therein or thereon - to the condominium form of ownership and use in the manner provided for in the Florida Condominium Act as it exists on the date hereof and as it may be hereafter renumbered. Without limiting any of the foregoing, no property, real, personal or mixed, not located within or upon the Land as aforesaid shall for any purposes be deemed part of the Condominium or be subject to the jurisdiction of the Association, the operation and effect of the Florida Condominium Act or any rules or regulations promulgated pursuant thereto, unless expressly provided.
- 1.3 Name. The name by which this condominium is to be identified is **THE FOUNTAINS AT METRO WEST, A CONDOMINIUM** (hereinafter called the "Condominium").

2. Definitions. The following terms when used in this Declaration and in its exhibits, and as it and they may hereafter be amended, shall have the respective meanings ascribed to them in this Section, except where the context clearly indicates a different meaning:

- 2.1 "Act" means the Florida Condominium Act (Chapter 718 of the Florida Statutes) as it exists on the date hereof and as it may be hereafter renumbered.
- 2.2 "Articles" or "Articles of Incorporation" mean the Articles of Incorporation of the Association, as amended from time to time.
- 2.3 "Assessment" means a share of the funds required for the payment of Common Expenses which from time to time is assessed against the Unit Owner.
- 2.4 "Association" or "Condominium Association" means **THE FOUNTAINS AT METRO WEST CONDOMINIUM ASSOCIATION, INC., a Florida corporation not for profit**, the sole entity responsible for the operation of the Condominium.
- 2.5 "Association Property" means that property, real and personal, which is owned or leased by, or is dedicated by a recorded plat to, the Association for the use and benefit of its members.
- 2.6 "Board" or "Board of Directors" means the board of directors, from time to time, of the Association.
- 2.7 "Building" means the structure(s) in which the Units and the Common Elements are located, regardless of the number of such structures, which are located on the Condominium Property.

- 2.8 "By-Laws" mean the By-Laws of the Association, as amended from time to time.
- 2.9 "Charge" shall mean and refer to the imposition of any financial obligation by the Association which is not an Assessment as defined by Subsection 2.3 above. Accordingly, as to Charges, the Association will not have the enforcement remedies that the Act grants for the collection of Assessments.
- 2.10 "City" shall mean the City of Orlando, located within the County (as hereinafter defined) and the State of Florida.
- 2.11 "Committee" means a group of Board Members, Unit Owners or Board Members and Unit Owners appointed by the Board or a member of the Board to make recommendations to the Board regarding the proposed annual budget or to take action on behalf of the Board.
- 2.12 "Common Elements" mean and include:
- (a) The portions of the Condominium Property which are not included within either the Units and/or the Association Property.
  - (b) All structural columns and bearing walls located within the Condominium Property regardless of where located.
  - (c) Easements through Units for conduits, ducts, plumbing, wiring and other facilities for the furnishing of utility and other services to Units, the Common Elements and/or the Association Property.
  - (d) An easement of support in every portion of a Unit which contributes to the support of the Building.
  - (e) The property and installations required for the furnishing of utilities and other services to more than one Unit or to the Common Elements and/or to the Association Property.
  - (f) Any and all portions of the Life Safety Systems (as hereinafter defined), regardless of where located within the Condominium Property.
  - (g) Any other parts of the Condominium Property designated as Common Elements in this Declaration, which shall specifically include the surface water management system, if any, of the Condominium Property.
- 2.13 "Common Expenses" mean all expenses incurred by the Association for the operation, management, maintenance, repair, replacement or protection of the Common Elements and Association Property, the costs of carrying out the powers and duties of the Association, and any other expense, whether or not included in the foregoing, designated as a "Common Expense" by the Act, the Declaration, the Articles or the Bylaws. For all purposes of this Declaration, "Common Expenses" shall also include, without limitation: (a) all reserves required by the Act or otherwise established by the Association, regardless of when reserve funds are expended; (b) the cost of a master antenna television system or duly franchised cable television service obtained pursuant to a bulk contract, if any; (c) the cost of any bulk contract for broadband, telecommunications, satellite and/or internet services, if any, (d) if applicable, costs relating to reasonable transportation services, road maintenance and operation expenses, management, administrative, professional and consulting fees and expenses, and in-house and/or interactive communications and surveillance systems; (e) the real property taxes, Assessments and other maintenance expenses attributable to any Units acquired by the Association or any Association Property; (f) to the extent that the Association determines to install exterior storm shutters, all expense of installation, repair, and maintenance of same by the Board (provided, however, that a Unit Owner who has already installed exterior storm shutters

(or other acceptable hurricane protection) for his or her Unit shall receive a credit equal to the pro rata portion of the assessed installation cost assigned to each Unit, but shall not be excused from any portion of expenses related to maintenance, repair, replacement or operation of same), including, without limitation, any and all costs associated with putting the shutters on in the event of an impending storm (without creating any obligation on the part of the Association to do so) and, if the Association elected to put shutters on, the costs of taking the shutters off once the storm threat passes; (g) any lease or maintenance agreement payments required under leases or maintenance agreements for mechanical or other equipment and/or supplies, including, without limitation, leases for recycling and/or trash compacting equipment, etc., if same is leased by the Association rather than being owned by it; (h) the costs associated with maintaining any portion of the Common Areas to the extent delegated to the Association by the Master Association as provided for in the Master Covenants; (i) all expenses related to the installation, repair, maintenance, operation, alteration and/or replacement of Life Safety Systems; (j) any unpaid share of Common Expenses or Assessments extinguished by foreclosure of a superior lien or by deed in lieu of foreclosure; (k) costs of fire, windstorm, flood, liability and all other types of insurance including, without limitation, and specifically, insurance for officers and directors of the Association; (l) costs of water and sewer, electricity, gas and other utilities which are not consumed by and metered to individual Units; (m) costs resulting from damage to the Condominium Property which are necessary to satisfy any deductible and/or to effect necessary repairs which are in excess of insurance proceeds received as a result of such damage; and (n) all costs, fees and assessments for which any Unit Owner or the Association may be obligated by virtue of the Master Covenants, as such Master Covenants may be amended or supplemented from time to time. Except as otherwise set forth in this section 2.13, Common Expenses shall not include any separate obligations of individual Unit Owners.

- 2.14 “Common Surplus” means the amount of all receipts or revenues, including Assessments, rents or profits, collected by the Association which exceeds Common Expenses.
- 2.15 “Condominium” shall have the meaning given to it in Subsection 1.3 above.
- 2.16 “Condominium Parcel” means a Unit together with the undivided share in the Common Elements which is appurtenant to said Unit.
- 2.17 “Condominium Property” means the Land, Improvements and other property or property rights described in Subsection 1.2 hereof, subject to the limitations thereof and exclusions therefrom.
- 2.18 “County” means Orange County in the State of Florida.
- 2.19 “Declaration” or “Declaration of Condominium” means this instrument and all exhibits attached hereto, as same may be amended from time to time.
- 2.20 “Developer” means **Birkat Raphael 1, LLC, a Delaware limited liability company**, its successors, nominees, affiliates and such of its assigns as to which the rights of Developer hereunder are specifically assigned. Developer may assign all or a portion of its rights hereunder, or all or a portion of such rights in connection with specific portions of the Condominium. In the event of any partial assignment, the assignee shall not be deemed the Developer, but may exercise such rights of Developer as are specifically assigned to it. Any such assignment may be made on a nonexclusive basis. Notwithstanding any assignment of the Developer’s rights hereunder (whether partially or in full), the assignee shall not be deemed to have assumed any of the obligations of the Developer unless, and only to the extent that, it expressly agrees to do so in writing. The rights of Developer under this Declaration are independent of the Developer’s rights to control the Board of Directors of the Association, and, accordingly, shall not be deemed waived, transferred or assigned to the Unit Owners, the Board or the Association upon the transfer of control of the Association.

- 2.21 “Dispute”, for purposes of Subsection 18.1, means any disagreement between two or more parties that involves: (a) the authority of the Board, under any law or under this Declaration, the Articles or By-Laws to: (i) require any Owner to take any action, or not to take any action, involving that Owner’s Unit or the appurtenances thereto; or (ii) alter or add to a common area or Common Element; or (b) the failure of the Association, when required by law or this Declaration, the Articles or By-Laws to: (i) properly conduct elections; (ii) give adequate notice of meetings or other actions; (iii) properly conduct meetings; or (iv) allow inspection of books and records. “Dispute” shall not include any disagreement that primarily involves title to any Unit or Common Element; the interpretation or enforcement of any warranty; or the levy of a fee or Assessment or the collection of an Assessment levied against a party.
- 2.22 “Division” means the Division of Florida Land Sales, Condominiums and Mobile Homes of the Department of Business and Professional Regulation, State of Florida, or its successor.
- 2.23 “First Mortgagee” shall have the meaning given to it in Subsection 13.6 below.
- 2.24 “Improvements” mean all structures and artificial changes to the natural environment (exclusive of landscaping) located or to be located on the Condominium Property, including, but not limited to, the Building.
- 2.25 “Institutional First Mortgagee” means a bank, savings and loan association, insurance company, mortgage company, real estate or mortgage investment trust, pension fund, private equity fund, an agency of the United States Government, mortgage banker, a government sponsored entity, the Federal National Mortgage Association (“FNMA”), the Federal Home Loan Mortgage Corporation (“FHLMC”), any lender advancing funds to Developer secured by an interest in any portion of the Condominium Property or any other lender generally recognized as an institutional lender, or the Developer, holding a first mortgage on a Unit or Units. A “Majority of Institutional First Mortgagees” shall mean and refer to Institutional First Mortgagees of Units to which at least fifty-one percent (51%) of the voting interests of Units subject to mortgages held by Institutional First Mortgagees are appurtenant.
- 2.26 “Insured Property” shall have the meaning given to it in Subsection 14.2(a) below.
- 2.27 “Land” shall have the meaning given to it in Subsection 1.1 above.
- 2.28 “Life Safety Systems” mean and refer to any and all emergency lighting, audio and visual signals, safety systems, sprinklers, emergency generators and smoke detection systems, which are now or hereafter installed in the Building, whether or not within the Units. All such Life Safety Systems, together with all conduits, wiring, electrical connections and systems related thereto, regardless of where located, shall be deemed Common Elements hereunder. Without limiting the generality of the foregoing, when the context shall so allow, the Life Safety Systems shall also be deemed to include all means of emergency ingress and egress, which shall include all stairways and stair landings. Notwithstanding the breadth of the foregoing definition, nothing herein shall be deemed to suggest or imply that the Building or the Condominium contains all such Life Safety Systems.
- 2.29 “Limited Common Elements” mean those Common Elements the use of which is reserved to a certain Unit or Units to the exclusion of other Units, as specified in this Declaration. References herein to Common Elements also shall include all Limited Common Elements unless the context would prohibit or it is otherwise expressly provided.
- 2.30 “Master Association” means Metrowest Master Association, Inc., a Florida corporation not for profit, being the entity responsible for the administration of the Master Covenants.

- 2.31 “Master Covenants” mean the Master Declaration of Protective Covenants and Restrictions for Metrowest, recorded at Official Records Book 3759, Page 2756 of the Public Records of the County, and when the context permits, shall also mean the Articles of Incorporation and By-Laws of the Master Association, all as now or hereafter amended, modified or supplemented.
- 2.32 “Material Amendment” shall have the meaning given to it in Subsection 6.2 below.
- 2.33 “Optional Property” shall have the meaning given to it in Subsection 14.5(b) below.
- 2.34 “Primary Institutional First Mortgagee” means the Institutional First Mortgagee which owns, at the relevant time, Unit mortgages securing a greater aggregate indebtedness than is owed to any other Institutional First Mortgagee.
- 2.35 “Unit” means a part of the Condominium Property which is subject to exclusive ownership. References herein to “Parcels” shall include Units unless the context prohibits or it is otherwise expressly provided.
- 2.36 “Unit Owner” or “Owner of a Unit” or “Owner” means a record owner of legal title to a Condominium Parcel.

Unless the context otherwise requires, any capitalized term not defined but used herein which is defined in the Master Covenants shall have the meaning given to such word or words in such document.

3. Description of Condominium.

- 3.1 Identification of Units. The Land has constructed thereon twenty-five (25) residential buildings containing a total of two hundred thirty-eight (238) Units. Each such Unit is identified by a separate numerical designation. The designation of each of such Units is set forth on **Exhibit “2”** attached hereto. Exhibit “2” consists of a survey of the Land, a graphic description of the Improvements located thereon, including, but not limited to, the Building in which the Units are located, and a plot plan thereof. Said Exhibit “2”, together with this Declaration, is sufficient in detail to identify the Common Elements and each Unit and their relative locations and dimensions. There shall pass with a Unit as appurtenances thereto: (a) an undivided share in the Common Elements and Common Surplus; (b) the exclusive right to use such portion of the Common Elements as may be provided in this Declaration; (c) an exclusive easement for the use of the airspace occupied by the Unit as it exists at any particular time and as the Unit may lawfully be altered or reconstructed from time to time, provided that an easement in airspace which is vacated shall be terminated automatically; (d) membership in the Association with the full voting rights appurtenant thereto; and (e) other appurtenances as may be provided by this Declaration.
- 3.2 Unit Boundaries. Each Unit shall include that part of the Building containing the Unit that lies within the following boundaries:
- (a) Upper and Lower Boundaries. The upper and lower boundaries of the Unit shall be the following boundaries extended to their planar intersections with the perimetrical boundaries:
- (i) Upper Boundaries. The horizontal plane of the unfinished lower surface of the ceiling (which will be deemed to be the ceiling of the upper story if the Unit is a multi-story Unit, provided that in multi-story Units where the lower boundary extends beyond the upper boundary, the upper boundary shall include that portion of the ceiling of the lower floor for which there is no corresponding ceiling on the upper floor directly above such bottom floor ceiling).

- (ii) Lower Boundaries. The horizontal plane of the unfinished upper surface of the floor of the Unit (which will be deemed to be the floor of the first story if the Unit is a multi-story Unit, provided that in multi-story Units where the upper boundary extends beyond the lower boundary, the lower boundary shall include that portion of the floor of the upper floor for which there is no corresponding floor on the bottom floor directly below the floor of such top floor).
    - (iii) Interior Divisions. Except as provided in subsections 3.2(a)(i) and 3.2(a)(ii) above, no part of the floor of the top floor, ceiling of the bottom floor, stairwell adjoining the multi-floors, in all cases of a multi-story Unit, if any, or nonstructural interior walls shall be considered a boundary of the Unit.
  - (b) Perimetrical Boundaries. The perimetrical boundaries of the Unit shall be the vertical planes of the unfinished interior surfaces of the walls bounding the Unit extended to their planar intersections with each other and with the upper and lower boundaries (and to the extent that the walls are drywall and/or gypsum board, the Unit boundaries shall be deemed to be the area immediately behind the drywall and/or gypsum board, so that for all purposes hereunder the drywall and/or gypsum board shall be deemed part of the Unit and not part of the Common Elements).
  - (c) Apertures. Where there are apertures in any boundary, including, but not limited to, windows, doors, bay windows and skylights, such boundaries shall be extended to include the windows, doors and other fixtures located in such apertures, including all frameworks, window casings and weather stripping thereof, together with exterior surfaces made of glass or other transparent materials; provided, however, that the exteriors of doors facing interior Common Element hallways shall not be included in the boundaries of the Unit and shall therefore be Common Elements. Notwithstanding anything to the contrary, the structural components of the Building and the Life Safety Systems, regardless of where located, are expressly excluded from the Units and are instead deemed Common Elements.
  - (d) Exceptions. In cases not specifically covered above, and/or in any case of conflict or ambiguity, the survey of the Units set forth as Exhibit "2" hereto shall control in determining the boundaries of a Unit, except that the provisions of Subsection 3.2(c) above shall control unless specifically depicted and labeled otherwise on such survey.
- 3.3 Limited Common Elements. Each Unit may have, to the extent applicable and subject to the provisions of this Declaration, as Limited Common Elements appurtenant thereto:
- (a) Porches and Storage appurtenant to Units. Any porch or storage area (and all improvements thereto) as to which direct and exclusive access shall be afforded to any particular Unit or Units to the exclusion of others shall be a Limited Common Element of such Unit(s). The Association shall be responsible for the maintenance of the structural and mechanical elements of any such Limited Common Elements, with the costs of same being a part of the Common Expenses. Each Unit Owner shall, however, be responsible for the maintenance of any other portions of such areas, for the general cleaning, plant care and upkeep of the appearance of the area(s) and for the repair and replacement of any existing floor coverings and/or any floor coverings hereafter placed or installed on any porch or storage area. A Unit Owner using a porch or storage area or making or causing to be made any additions, alterations or improvements thereto agrees, and shall be deemed to have agreed, for such Owner, and his or her heirs, personal representatives, successors and assigns, as appropriate, to hold the

Association, the Developer and all other Unit Owners harmless from and to indemnify them for any liability or damage to the Condominium and/or Association Property and expenses arising therefrom. BY ACQUIRING TITLE TO, OR TAKING POSSESSION OF, A UNIT, EACH OWNER, FOR SUCH OWNER AND SUCH OWNER'S TENANTS, GUESTS AND INVITEES, HEREBY EXPRESSLY ASSUMES ANY RESPONSIBILITY FOR LOSS, DAMAGE OR LIABILITY RESULTING THEREFROM OR FROM ANY LIMITED COMMON ELEMENTS APPURTENANT THERETO.

- (b) Garages. Until such time as Developer is no longer offering Units for sale in the ordinary course of business, Developer hereby reserves and shall have (and after such period the Association, acting through its Board, shall have) the right to assign, with or without consideration, the exclusive right to use any Garage now or hereafter located within the Common Elements of the Condominium to one or more Units, whereupon the space so assigned shall be deemed a Limited Common Element of the Unit(s) to which it is assigned. Such assignment shall not be recorded in the Public Records of the County but, rather, shall be made by way of instrument placed in the official records of the Association (as same are defined in the By-Laws). Further, a Limited Common Element Garage may be relocated at any time, and from time to time, by the Board to comply with applicable federal, state and local laws and regulations regarding or affecting handicap accessibility. A Unit Owner may assign the Limited Common Element Garage assigned to his or her Unit to another Unit by written instrument delivered to (and to be held by) the Association. The maintenance of any Garage so assigned shall be the responsibility of the Association (provided however, that the contents placed in any such Garage, including, without limitation, any vehicle maintained therein, and the insurance thereof, shall be the sole responsibility of the Unit Owner). Each Garage is designated on Exhibit "2" attached hereto with the label "Garage" followed by a numerical and/or alphanumeric designation for the Garage. EACH UNIT OWNER ACKNOWLEDGES AND AGREES THAT THE GARAGES ARE LOCATED IN FLOOD ZONE "X" OF THE FLOOD INSURANCE RATE MAP, COMMUNITY PANEL NO. 12095C 0240 E, WHICH BEARS A DATE OF DECEMBER 6, 2000. ZONE "X" REPRESENTS AN AREA OUTSIDE THE 500-YEAR FLOOD PLAIN; . ACCORDINGLY, IN THE EVENT OF FLOODING, ANY AUTOMOBILES AND/OR PERSONAL PROPERTY STORED THEREIN MAY BE SUSCEPTIBLE TO WATER DAMAGE. ADDITIONALLY, INSURANCE PREMIUMS, BOTH FOR THE ASSOCIATION IN INSURING THE PARKING FACILITIES, AND FOR OWNERS, MAY BE HIGHER THAN IF THE PARKING FACILITIES WERE NOT LOCATED IN FLOOD ZONE "X". BY ACQUIRING TITLE TO, OR TAKING POSSESSION OF, A UNIT, OR ACCEPTING THE ASSIGNMENT OF A GARAGE, EACH OWNER, FOR SUCH OWNER AND SUCH OWNER'S TENANTS, GUESTS AND INVITEES, HEREBY EXPRESSLY ASSUMES ANY RESPONSIBILITY FOR LOSS, DAMAGE OR LIABILITY RESULTING THEREFROM.
- (c) Miscellaneous Areas, Equipment. Except to the extent that same are located within the boundaries of a Unit, any fixtures or equipment (e.g., an air conditioning compressor, other portions of any air conditioning systems, and/or heater, if any, or hot water heater) serving a Unit or Units exclusively and any area (e.g., a closet, roof space or ground slab) upon/within which such fixtures or equipment are located shall be Limited Common Elements of such Unit(s). Without limiting the foregoing, each air conditioning unit (and all equipment and fixtures constituting an individual air conditioning system) located on the ground adjacent to a Building which serves one Unit shall be deemed a Limited Common Element of the Unit it serves. The maintenance (and cost) of any such fixtures and/or equipment and/or areas so assigned shall be the sole responsibility

Declaration

7

of the Owner of the Unit(s) to which the fixtures and/or equipment are appurtenant.

- (d) Other. If applicable, any other portion of the Common Elements which, by its nature, cannot serve all Units but serves one Unit or more than one Unit shall be deemed a Limited Common Element of the Unit(s) served and shall be maintained by said Owner. In the event of any doubt or dispute as to whether any portion of the Common Elements constitutes a Limited Common Element or in the event of any question as to which Units are served thereby, a decision shall be made by a majority vote of the Board of Directors of the Association and shall be binding and conclusive when so made. To the extent of any area deemed a Limited Common Element under this Subsection 3.3(d), the Owner of the Unit(s) to which the Limited Common Element is appurtenant shall have the right to alter same as if the Limited Common Element were part of the Owner's Unit, rather than as required for alteration of Common Elements. Notwithstanding the foregoing, the designation of any portion of the Common Elements as a Limited Common Element under this Subsection 3.3(d) shall not allow the Owner of the Unit to which the Limited Common Element is appurtenant to preclude, or in any way interfere with the passage through such areas as may be needed from time to time for emergency ingress and egress, and for the maintenance, repair, replacement, alteration and/or operation of the Life Safety Systems, mechanical equipment and/or other Common Elements which are most conveniently serviced (in the sole determination of the Board) by accessing such areas (and an easement is hereby reserved for such purposes).

3.4 Easements. The following easements are hereby created (in addition to any easements created under the Act and any easements affecting the Condominium Property and recorded in the Public Records of the County):

- (a) Support. Each Unit and any structure and/or Improvement now or hereafter constructed adjacent thereto shall have an easement of support and of necessity and shall be subject to an easement of support and necessity in favor of all other Units, the Common Elements and/or the Association Property, and any other structure or improvement which abuts any Unit, the Building or any Improvements, including without limitation, any structures now or hereafter governed by the Master Covenants.
- (b) Utility and Other Services; Drainage. Easements are reserved under, through and over the Condominium Property as may be required from time to time for utility, cable television, communications and monitoring systems, Life Safety Systems, digital and/or other satellite systems, broadband communications and other services and drainage in order to serve the Condominium and/or members of the Association and/or the Master Association. A Unit Owner shall do nothing within or outside his or her Unit that interferes with or impairs, or may interfere with or impair, the provision of such utility, cable television, communications, monitoring systems, Life Safety Systems, digital and/or other satellite systems, broadband communications or other service or drainage facilities or the use of these easements. The Association shall have an irrevocable right of access to each Unit to maintain, repair or replace the pipes, wires, ducts, vents, cables, conduits and other utility, cable television, communications, monitoring systems, Life Safety Systems, digital and/or other satellite systems, broadband communications and similar systems, hot water heaters, service and drainage facilities, and Common Elements contained in the Unit or elsewhere in the Condominium Property, and to remove any Improvements interfering with or impairing such facilities or easements herein reserved; provided such right of access, except in the event of an emergency, shall not unreasonably interfere with the Unit Owner's permitted use of the Unit, and except in the event of an emergency, entry shall be made on not less than one (1) days' notice (which



notice shall not, however, be required if the Unit Owner is absent when the giving of notice is attempted).

- (c) Encroachments. If (i) any portion of the Common Elements and/or the Association Property encroaches upon any Unit (or Limited Common Element appurtenant thereto) or other portions of the Common Areas; (ii) any Unit (or Limited Common Element appurtenant thereto) encroaches upon any other Unit or upon any portion of the Common Elements and/or Association Property and/or Common Areas; (iii) any Improvements encroach upon Common Areas or the property of any other Lot within the Community (iv) any Common Areas or "improvements" of another Lot within the Community encroach upon the Condominium Property; or (v) any encroachment shall hereafter occur as a result of (A) settling or shifting of the Improvements; (B) any alteration or repair to the Common Elements and/or the Association Property made by or with the consent of the Association or Developer, as appropriate, or (C) any repair or restoration of the Improvements (or any portion thereof) or any Unit after damage by fire or other casualty or any taking by condemnation or eminent domain proceedings of all or any portion of any Unit or the Common Elements and/or the Association Property, then, in any such event, a valid easement shall exist for such encroachment and for the maintenance of same so long as the Improvements, the affected Common Areas or the relevant "improvements" upon another Lot within the Community shall stand.
- (d) Ingress and Egress. A non-exclusive easement in favor of each Unit Owner and resident, their guests and invitees, and for each member of the Association and the Master Association shall exist for pedestrian traffic over, through and across sidewalks, streets, paths, walks, and other portions of the Common Elements and Association Property as from time to time may be intended and designated for such purpose and use by the Board; and for vehicular and pedestrian traffic over, through and across, and parking on, such portions of the Common Elements and Association Property as from time to time may be paved and intended for such purposes. None of the easements specified in this Subsection 3.4(d) shall be encumbered by any leasehold or lien other than those on the Condominium Parcels. Any such lien encumbering such easements (other than those on Condominium Parcels) automatically shall be subordinate to the rights of Unit Owners and the Association with respect to such easements.
- (e) Construction; Maintenance. The Developer (including its affiliates and its or their designees, contractors, successors and assigns) shall have the right, in its (and their) sole discretion from time to time, to enter the Condominium Property and take all other action necessary or convenient for the purpose of undertaking and completing the construction and/or renovation thereof, or any improvements, structures, facilities or Units located or to be located thereon, and/or any improvements to be located adjacent thereto and for repair, replacement and maintenance or warranty purposes or where the Developer, in its sole discretion, determines that it is required or desires to do so. The Association (and its designees, contractors, subcontractors, employees) shall have the right to have access to each Unit from time to time during reasonable hours as may be necessary for pest control purposes and for the maintenance, repair or replacement of any Common Elements or any portion of a Unit, if any, to be maintained by the Association, or at any time and by force, if necessary, to prevent damage to the Common Elements, the Association Property or to a Unit or Units, including, without limitation, (but without obligation or duty) to close exterior storm shutters in the event of the issuance of a storm watch or storm warning.
- (f) Sales and Leasing Activity. Until such time as Developer (or any of its affiliates) is no longer offering Units for sale in the ordinary course of its business, the

Developer, its designees, successors and assigns, hereby reserves and shall have the right to use any Units owned by Developer (or its affiliates) and all of the Common Elements or Association Property for guest accommodations, model apartments and sales, leasing, management, resales, administration and construction offices, to provide financial services, to show model Units and/or apartments and the Common Elements and/or any other portions of the Condominium Property to prospective purchasers and tenants of Units, and/or to erect on the Condominium Property and Association Property signs, displays and other promotional material to advertise Units or other properties for sale or lease in the Condominium (and an easement is hereby reserved for all such purposes and without the requirement that any consideration be paid by the Developer to the Association or to any Unit Owner).

- (g) Exterior Building Maintenance. An easement is hereby reserved on, through and across each Unit and all Limited Common Elements appurtenant thereto in order to afford access to the Association (and its contractors) to perform roof repairs and/or replacements, repair, replace, maintain and/or alter rooftop mechanical equipment, if any, to stage window washing equipment and to perform window washing and/or any other exterior maintenance and/or painting of the Building.
- (h) Master Association Easements. The Master Association and its agents, employees, contractors and assigns shall have an easement to enter onto the Condominium Property for the purpose of performing such functions as are permitted or required to be performed by such Association by the Master Covenants, including, but not limited to, maintenance, repair, replacement and alteration of Common Areas, as and to the extent permitted by the Master Covenants. All easements and rights provided for in the Master Covenants in favor of the Master Association, its respective members are hereby granted to said Master Association and its members, as and to the extent provided by the Master Covenants.
- (i) Warranty. For as long as Developer remains liable under any warranty, whether statutory, express or implied, for acts or omissions of Developer in the development, construction, sale, resale, leasing, financing and marketing of the Condominium, then Developer and its contractors, agents and designees shall have the right, in Developer's sole discretion and from time to time and without requiring prior approval of the Association and/or any Unit Owner and without requiring any consideration to be paid by the Developer to the Unit Owners and/or Condominium Association (provided, however, that absent an emergency situation, Developer shall provide reasonable advance notice), to enter the Condominium Property, including the Units, Common Elements and Limited Common Elements, for the purpose of inspecting, testing and surveying same to determine the need for repairs, improvements and/or replacements, and effecting same, so that Developer can fulfill any of its warranty obligations. The failure of the Association or any Unit Owner to grant, or to interfere with, such access, shall alleviate the Developer from having to fulfill its warranty obligations and the costs, expenses, liabilities or damages arising out of any unfulfilled Developer warranty will be the sole obligation and liability of the person or entity who or which impedes the Developer in any way in Developer's activities described in this Subsection 3.4(i). The easements reserved in this Section shall expressly survive the transfer of control of the Association to Unit Owners other than the Developer. **Nothing herein shall be deemed or construed as the Developer making or offering any warranty, all of which are disclaimed (except to the extent same may not be or are expressly set forth herein) as set forth in Section 22 below.**
- (j) Additional Easements. The Association, through its Board, on the Association's behalf and on behalf of all Unit Owners (each of whom hereby appoints the

Association as its attorney-in-fact for this purpose), shall have the right to grant such additional general ("blanket") and specific electric, gas or other utility, cable television, security systems, communications or service easements (and appropriate bills of sale for equipment, conduits, pipes, lines and similar installations pertaining thereto), or modify or relocate any such existing easements or drainage facilities, in any portion of the Condominium and/or Association Property, and to grant access easements or relocate any existing access easements in any portion of the Condominium and/or Association Property, as the Board shall deem necessary or desirable for the proper operation and maintenance of the Improvements, or any portion thereof, or any improvement located on Common Areas or within the Community or for the general health or welfare of the Unit Owners and/or members of the Association, or for the purpose of carrying out any provisions of this Declaration or of the Master Covenants, provided that such easements or the relocation of existing easements will not prevent or unreasonably interfere with the reasonable use of the Units for dwelling purposes.

4. Restraint Upon Separation and Partition of Common Elements. The undivided share in the Common Elements and Common Surplus which is appurtenant to a Unit, and the exclusive right to use all appropriate appurtenant Limited Common Elements, shall not be separated therefrom and shall pass with the title to the Unit, whether or not separately described. The appurtenant share in the Common Elements and Common Surplus, and the exclusive right to use all Limited Common Elements appurtenant to a Unit, except as elsewhere herein provided to the contrary, cannot be conveyed or encumbered except together with the Unit. The respective shares in the Common Elements appurtenant to Units shall remain undivided, and no action for partition of the Common Elements, the Condominium Property, or any part thereof, shall lie, except as provided herein with respect to termination of the Condominium.
5. Ownership of Common Elements and Common Surplus and Share of Common Expenses; Voting Rights
  - 5.1 Percentage Ownership and Shares. The undivided percentage interest in the Common Elements and Common Surplus, and the percentage share of the Common Expenses, appurtenant to each Unit, is as set forth on **Exhibit "3"** attached hereto and is based upon the total square footage of each Unit in uniform relationship to the total square footage of each other Unit.
  - 5.2 Voting. Each Unit shall be entitled to one (1) vote to be cast by its Owner in accordance with the provisions of the By-Laws and Articles of Incorporation of the Association. Each Unit Owner shall be a member of the Association.
6. Amendments. Except as elsewhere provided herein, amendments may be effected as follows:
  - 6.1 By The Association. Notice of the subject matter of a proposed amendment shall be included in the notice of any meeting at which a proposed amendment is to be considered. A resolution for the adoption of a proposed amendment may be proposed either by a majority of the Board of Directors of the Association or by not less than one-third (1/3) of the Unit Owners. Except as elsewhere provided, approvals must be by an affirmative vote representing in excess of 66 2/3% of the voting interests of all Unit Owners. Directors and Unit Owners not present in person at the meeting considering the amendment may express their approval or disapproval in writing, provided that such approval or disapproval is delivered to the secretary at or prior to the meeting, however, such approval or disapproval may not be used as a vote for or against the action taken and may not be used for the purpose of creating a quorum.
  - 6.2 Material Amendments. Unless otherwise provided specifically to the contrary in this Declaration, no amendment shall change the configuration or size of any Unit in any material fashion, materially alter or modify the appurtenances to any Unit, or change the

percentage by which the Owner of a Unit shares the Common Expenses and owns the Common Elements and Common Surplus (any such change or alteration being a "Material Amendment"), unless the record Owner(s) thereof, and all record owners of mortgages or other liens thereon, shall join in the execution of the amendment and the amendment is otherwise approved by in excess of 66 2/3% of the voting interests of Unit Owners. The acquisition of property by the Association, material alterations or substantial additions to such property or the Common Elements by the Association and installation, replacement, operation, repair and maintenance of approved exterior storm shutters, if in accordance with the provisions of this Declaration, shall not be deemed to constitute a material alteration or modification of the appurtenances of the Units, and accordingly, shall not constitute a Material Amendment.

- 6.3 Mortgagee's Consent. No amendment may be adopted which would eliminate, modify, prejudice, abridge or otherwise adversely affect any rights, benefits, privileges or priorities granted or reserved to any Institutional First Mortgagees or the Primary Institutional First Mortgagee without the consent of the aforesaid Institutional First Mortgagees in each instance; nor shall an amendment make any change in the sections hereof entitled "Insurance", "Reconstruction or Repair after Casualty", or "Condemnation" unless the Primary Institutional First Mortgagee shall join in the amendment. Except as specifically provided herein or if required by FNMA or FHLMC, the consent and/or joinder of any lien or mortgage holder on a Unit shall not be required for the adoption of an amendment to this Declaration and, whenever the consent or joinder of a lien or mortgage holder is required, such consent or joinder shall not be unreasonably withheld.
- 6.4 By or Affecting the Developer. Notwithstanding anything herein contained to the contrary, during the time the Developer has the right to elect a majority of the Board of Directors of the Association, the Declaration, the Articles of Incorporation or the By-Laws of the Association may be amended by the Developer alone, without requiring the consent of any other party, to effect any change whatsoever, except for an amendment: (a) to permit time-share estates (which must be approved, if at all, by all Unit Owners and mortgagees on Units); or (b) to effect a Material Amendment which must be approved, if at all, in the manner set forth in Subsection 6.2 above. The unilateral amendment right set forth herein shall include, without limitation, the right to correct scrivener's errors. No amendment may be adopted (whether to this Declaration or any of the exhibits hereto) which would eliminate, modify, prejudice, abridge or otherwise adversely affect any rights, benefits, privileges or priorities granted or reserved to the Developer, without the prior written consent of the Developer in each instance.
- 6.5 Execution and Recording. An amendment, other than amendments made by the Developer alone pursuant to the Act or this Declaration, shall be evidenced by a certificate of the Association, executed either by the President of the Association or a majority of the members of the Board of Directors which shall include recording data identifying the Declaration and shall be executed with the same formalities required for the execution of a deed. An amendment of the Declaration is effective when the applicable amendment is properly recorded in the public records of the County. No provision of this Declaration shall be revised or amended by reference to its title or number only. Proposals to amend existing provisions of this Declaration shall contain the full text of the provision to be amended; new words shall be inserted in the text underlined; and words to be deleted shall be lined through with hyphens. However, if the proposed change is so extensive that this procedure would hinder, rather than assist, the understanding of the proposed amendment, it is not necessary to use underlining and hyphens as indicators of words added or deleted, but, instead, a notation must be inserted immediately preceding the proposed amendment in substantially the following language: "Substantial rewording of Declaration. See provision . . . for present text." Nonmaterial errors or omissions in the amendment process shall not invalidate an otherwise properly adopted amendment.

- 6.6 Master Association Consent. No amendment may be adopted which would prejudice, abridge or otherwise adversely affect any rights, benefits, privileges or priorities granted or reserved to the Master Association without the written consent of the Master Association in each instance.
7. Maintenance and Repairs.
- 7.1 Units and Limited Common Elements. All maintenance, repairs and replacements of, in or to any Unit and Limited Common Elements appurtenant thereto, whether structural or nonstructural, ordinary or extraordinary, foreseen or unforeseen, including, without limitation, maintenance, repair and replacement of windows, window coverings, interior nonstructural walls, the interior side of any entrance door and all other doors within or affording access to a Unit, and the electrical (including wiring), plumbing (including fixtures and connections), heating and air-conditioning equipment, fixtures and outlets, appliances, carpets and other floor coverings, all interior surfaces and the entire interior of the Unit lying within the boundaries of the Unit or the Limited Common Elements or other property belonging to the Unit Owner, shall be performed by the Owner of such Unit at the Unit Owner's sole cost and expense, except as otherwise expressly provided to the contrary herein.
- 7.2 Common Elements and Association Property. Except to the extent (i) expressly provided to the contrary herein, or (ii) proceeds of insurance are made available therefor, all maintenance, repairs and replacements in or to the Common Elements (other than those Limited Common Elements to be maintained by the Unit Owners as provided above) and Association Property shall be performed by the Association and the cost and expense thereof shall be assessed to all Unit Owners as a Common Expense, except to the extent arising from or necessitated by the negligence, misuse or neglect of specific Unit Owners, in which case such cost and expense shall be paid solely by such Unit Owners as a Charge.
- 7.3 Specific Unit Owner Responsibility. The obligation to maintain and repair any air conditioning and heating equipment, plumbing or electrical feeds, fixtures, screens (whether on windows or doors), screened enclosures and screen doors serving the Unit, or other items of property which service a particular Unit or Units (to the exclusion of other Units), including, without limitation, any exterior storm shutters protecting doors or windows for a particular Unit, shall be the responsibility of the applicable Unit Owners, individually, and not the Association, without regard to whether such items are included within the boundaries of the Units.
8. Additions, Improvements or Alterations by the Association. Whenever in the judgment of the Board of Directors, the Common Elements, the Association Property, or any part of either, shall require capital additions, alterations or improvements (as distinguished from repairs and replacements) costing in excess of the "Threshold Amount" in the aggregate in any calendar year, the Association may proceed with such additions, alterations or improvements only if the making of such additions, alterations or improvements shall have been approved by an affirmative vote representing a majority of the voting interests represented at a meeting at which a quorum is attained. Any such additions, alterations or improvements to such Common Elements, the Association Property, or any part of either, costing in the aggregate the Threshold Amount or less in a calendar year may be made by the Association without approval of the Unit Owners. The cost and expense of any such additions, alterations or improvements to such Common Elements or Association Property shall constitute a part of the Common Expenses and shall be assessed to the Unit Owners as Common Expenses. For purposes hereof, the "Threshold Amount" shall mean and refer to:
- (a) from the period commencing upon the recordation of this Declaration and ending on the date that control of the Association is transferred from the Developer to Unit Owners

other than the Developer (the "Transition Date"), an amount equal to fifteen percent (15%) of the then estimated operating budget of the Association, and

- (b) from and after the Transition Date, an amount equal to three percent (3%) of the then estimated operating budget of the Association.

For purposes of this Section, "aggregate in any calendar year" shall include the total debt incurred in that year, if such debt is incurred to perform the above-stated purposes, regardless of whether the repayment of any part of that debt is required to be made beyond that year. All additions, alterations and improvements proposed to be made by the Association may also be subject to the specific action and veto rights of the Design Review Board, as provided in the Master Covenants.

9. Additions, Alterations or Improvements by Unit Owner.

- 9.1 Consent of the Board of Directors. No Unit Owner shall make any addition, alteration or improvement in or to the Common Elements, the Association Property, any structural addition, alteration or improvement in or to his or her Unit, the Common Elements or any Limited Common Element or any change to his or her Unit which is visible from any other Unit, the Common Elements, the Association Property and/or the Common Areas, without, in each instance, the prior written consent of the Board of Directors of the Association and the Master Association, to the extent required by the Master Covenants. Without limiting the generality of this Subsection 9.1, no Unit Owner shall cause or allow improvements or changes to his or her Unit, or to any Limited Common Elements, Common Elements or any property of the Condominium Association which does or could in any way affect, directly or indirectly, the structural, electrical, plumbing, Life Safety Systems, or mechanical systems, or any landscaping or drainage, of any portion of the Condominium Property without first obtaining the written consent of the Board of the Association. The Board shall have the obligation to answer, in writing, any written request by a Unit Owner for approval of such an addition, alteration or improvement within thirty (30) days after such request and all additional information requested is received, and the failure to do so within the stipulated time shall constitute the Board's consent. The Board may condition the approval in any manner, including, without limitation, retaining approval rights of the contractor to perform the work, imposing conduct standards on all such workers, establishing permitted work hours and requiring the Unit Owner to obtain insurance naming the Developer and the Association as additional named insureds. The proposed additions, alterations and improvements by the Unit Owners shall be made in compliance with all laws, rules, ordinances and regulations of all governmental authorities having jurisdiction, and with any conditions imposed by the Association with respect to design, structural integrity, aesthetic appeal, construction details, lien protection or otherwise. Once approved by the Board of Directors, such approval may not be revoked.

A Unit Owner making or causing to be made any such additions, alterations or improvements agrees, and shall be deemed to have agreed, for such Unit Owner, and such Owner's heirs, personal representatives, successors and assigns, as appropriate, to hold the Association, the Developer and all other Unit Owners harmless from and to indemnify them against any liability or damage to the Condominium and/or Association Property and expenses arising therefrom, and shall be solely responsible for the maintenance, repair and insurance thereof from and after that date of installation or construction thereof as may be required by the Association. The Association's rights of review and approval of plans and other submissions under this Declaration are intended solely for the benefit of the Association. Neither the Developer, the Association nor any of its officers, directors, employees, agents, contractors, consultants or attorneys shall be liable to any Owner or any other person by reason of mistake in judgment, failure to point out or correct deficiencies in any plans or other submissions, negligence, or any other misfeasance, malfeasance or nonfeasance arising out of or in connection with the approval or disapproval of any plans or submissions.

Anyone submitting plans hereunder, by the submission of same, and any Owner, by acquiring title to same, agrees not to seek damages from the Developer and/or the Association arising out of the Association's review of any plans hereunder. Without limiting the generality of the foregoing, the Association shall not be responsible for reviewing, nor shall its review of any plans be deemed approval of, any plans from the standpoint of structural safety, soundness, workmanship, materials, usefulness, conformity with building or other codes or industry standards, or compliance with governmental requirements. Further, each Owner (including the successors and assigns) agrees to indemnify and hold the Developer and the Association harmless from and against any and all costs, claims (whether rightfully or wrongfully asserted), damages, expenses or liabilities whatsoever (including, without limitation, reasonable attorneys' fees and court costs at all trial and appellate levels), arising out of any review of plans by the Association hereunder.

9.2 Life Safety Systems. No Unit Owner shall make any additions, alterations or improvements to the Life Safety Systems, and/or to any other portion of the Condominium Property which may alter or impair the Life Safety Systems or access to the Life Safety Systems, without first receiving the prior written approval of the Board. In that regard, no lock, chain or other device or combination thereof shall be installed or maintained at any time on or in connection with any door on which panic hardware or fire exit hardware is required. Stairwell identification and emergency signage shall not be altered or removed in any manner whatsoever by any Unit Owner. No barrier including, but not limited to personalty, shall impede the free movement of ingress and egress to and from all emergency ingress and egress passageways.

9.3 Improvements, Additions or Alterations by Developer. Anything to the contrary notwithstanding, the foregoing restrictions of this Section 9 shall not apply to Developer-owned Units and/or improvements made thereto. The Developer shall have the additional right, without the consent or approval of the Association, the Board of Directors or other Unit Owners, to (a) make alterations, additions or improvements, structural and non-structural, interior and exterior, ordinary and extraordinary, in, to and upon any Unit owned by it and Limited Common Elements appurtenant thereto (including, without limitation, the removal of walls, windows, doors, glass sliding doors, floors, ceilings and other structural portions of the Improvements and/or the installation of signs), and (b) expand or add to all or any part of the recreational facilities. Any amendment to this Declaration required by a change made by the Developer pursuant to this Subsection 9.3 shall be adopted in accordance with Section 6 and Section 10 of this Declaration.

10. Changes in Developer-Owned Units. Without limiting the generality of the provisions of Subsection 9.3 above, and anything to the contrary notwithstanding, the Developer shall have the right, without the vote or consent of the Association or Unit Owners, to (a) make alterations, additions or improvements in, to and upon Units owned by the Developer, whether structural or non-structural, interior or exterior, ordinary or extraordinary; (b) change the layout or number of rooms in any Developer owned Units; (c) change the size of Developer owned Units by combining separate Developer owned Units into a single apartment (although being kept as two separate legal Units), or otherwise; and (d) reapportion among the Developer owned Units affected by such change in size pursuant to the preceding clause, their appurtenant interests in the Common Elements and share of the Common Surplus and Common Expenses; provided, however, that the percentage interest in the Common Elements and share of the Common Surplus and Common Expenses of any Units (other than the affected Developer-owned Units) shall not be changed by reason thereof unless the Owners of such Units shall consent thereto and, provided further, that Developer shall comply with all laws, ordinances and regulations of all governmental authorities having jurisdiction in so doing. In making the above alterations, additions and improvements, the Developer may relocate and alter Common Elements adjacent to or near such Units, incorporate portions of the Common Elements into adjacent Units and incorporate Units, or portions thereof, into adjacent Common Elements, provided that such relocation and alteration does not materially adversely affect the market value or ordinary use of Units owned by Unit

Owners other than the Developer. Any amendments to this Declaration required by changes of the Developer made pursuant to this Section 10, shall be effected by the Developer alone pursuant to Subsection 6.5, without the vote or consent of the Association or Unit Owners (or their mortgagees) required, except to the extent that any of same constitutes a Material Amendment, in which event, the amendment must be approved as set forth in Subsection 6.2 above. Without limiting the generality of Subsection 6.5 hereof, the provisions of this Section may not be added to, amended or deleted without the prior written consent of the Developer.

11. Operation of the Condominium by the Association; Powers and Duties.

11.1 Powers and Duties. The Association shall be the entity responsible for the operation of the Condominium and the Association Property. The powers and duties of the Association shall include those set forth in the By-Laws and Articles of Incorporation of the Association (respectively, **Exhibits "4" and "5"** annexed hereto), as amended from time to time. The affairs of the Association shall be governed by a Board of not less than three (3) nor more than nine (9) directors. Directors must be natural persons who are 18 years of age or older. Any person who has been convicted of any felony by any court of record in the United States and who has not had his or her right to vote restored pursuant to law in the jurisdiction of his or her residence is not eligible for Board membership (provided, however, that the validity of any Board action is not affected if it is later determined that a member of the Board is ineligible for Board membership due to having been convicted of a felony). In addition, the Association shall have all the powers and duties set forth in the Act, as well as all powers and duties granted to or imposed upon it by this Declaration, including, without limitation:

- (a) The irrevocable right to have access to each Unit and any Limited Common Elements appurtenant thereto from time to time during reasonable hours as may be necessary for pest control, or other purposes and for the maintenance, repair or replacement of any Common Elements or any portion of a Unit, if any, to be maintained by the Association, or at any time and by force, if necessary, to prevent damage to the Common Elements, the Association Property or to a Unit or Units, including, without limitation, (but without obligation or duty) to install and/or close exterior storm shutters in the event of the issuance of a storm watch or storm warning and/or to maintain, repair, replace and/or operate Life Safety Systems. Unless the Association expressly assumes the obligation to install and/or close exterior storm shutters in the event of the issuance of a storm watch or storm warning, the obligation to put shutters on, and then remove shutters, intended to protect individual Units shall be the sole obligation of the Unit Owner.
- (b) The power to make and collect Assessments and other Charges against Unit Owners and to lease, maintain, repair and replace the Common Elements and Association Property.
- (c) The duty to maintain accounting records according to good accounting practices, which shall be open to inspection by Unit Owners or their authorized representatives at reasonable times upon prior written request.
- (d) The Association shall assume all of Developer's and/or its affiliates' responsibilities to the City, the County, and its and their governmental and quasi-governmental subdivisions and similar entities of any kind with respect to the Condominium Property (including, without limitation, any and all obligations imposed by any permits or approvals issued by the County, as same may be amended, modified or interpreted from time to time) and, in either such instance, the Association shall indemnify and hold Developer and its affiliates harmless with respect thereto in the event of the Association's failure to fulfill those responsibilities.



- (e) The power to contract for the management and maintenance of the Condominium Property and to authorize a management agent (who may be an affiliate of the Developer) to assist the Association in carrying out its powers and duties by performing such functions as reviewing and evaluating the submission of proposals, collection of Assessments, preparation of records, enforcement of rules and maintenance, repair and replacement of Common Elements with such funds as shall be made available by the Association for such purposes. The Association and its officers shall, however, retain at all times the powers and duties granted in the Condominium documents and the Condominium Act, including, but not limited to, the making of Assessments, promulgation of rules and execution of contracts on behalf of the Association.
- (f) The power to borrow money, execute promissory notes and other evidences of indebtedness and to give as security therefor mortgages and security interests in property owned by the Association, if any, provided that such actions are approved by a majority of the entire membership of the Board of Directors and a majority of the voting interests represented at a meeting at which a quorum has been attained, or by such greater percentage of the Board or Unit Owners as may be specified in the By-Laws with respect to certain borrowing. The foregoing restriction shall not apply if such indebtedness is entered into for the purpose of financing insurance premiums, which action may be undertaken solely by the Board of Directors, without requiring a vote of the Unit Owners.
- (g) The power to adopt and amend rules and regulations concerning the details of the operation and use of the Common Elements and Association Property.
- (h) The power to acquire, convey, lease and encumber real and personal property. Personal property shall be acquired, conveyed, leased or encumbered upon a majority vote of the Board of Directors, subject to Section 8 hereof. Real property (including, without limitation, any of the Units) shall be acquired, conveyed, leased or encumbered upon a majority vote of the Board of Directors alone; provided that the requirements of Section 8 pertaining to the Unit Owners' approval of costs in excess of the threshold amount stated therein (including the proviso regarding the debt incurred) shall also apply to the acquisition of real property; provided, further, however, that the acquisition of any Unit as a result of a foreclosure of the lien for Assessments (or by deed in lieu of foreclosure) shall be made upon the majority vote of the Board, regardless of the price for same and the Association, through its Board, has the power to hold, lease, mortgage or convey the acquired Unit(s) without requiring the consent of Unit Owners. The expenses of ownership (including the expense of making and carrying any mortgage related to such ownership), rental, membership fees, taxes, Assessments, operation, replacements and other expenses and undertakings in connection therewith shall be Common Expenses.
- (i) The power to execute all documents or consents, on behalf of all Unit Owners (and their mortgagees), required by all governmental and/or quasi-governmental agencies in connection with land use and development matters (including, without limitation, plats, waivers of plat, unities of title, covenants in lieu thereof, etc.), relating to the Condominium Property, and in that regard, each Owner, by acceptance of the deed to such Owner's Unit, and each mortgagee of a Unit by acceptance of a lien on said Unit, appoints and designates the President of the Association, as such Owner's agent and attorney-in-fact to execute any and all such documents or consents.
- (j) The power to perform those acts which may be assigned to the Association from time to time by the Master Association, including, without limitation, the collection of assessments due to the Master Association.

- (k) All of the powers which a corporation not for profit in the State of Florida may exercise pursuant to this Declaration, the Articles of Incorporation, the Bylaws, Chapters 607 and 617, Florida Statutes and the Act, in all cases except as expressly limited or restricted in the Act.

In the event of conflict among the powers and duties of the Association or the terms and provisions of this Declaration, exhibits attached hereto and the Master Covenants or otherwise, the Master Covenants shall take precedence over this Declaration; this Declaration shall take precedence over the Articles of Incorporation, By-Laws and applicable rules and regulations; the Articles of Incorporation shall take precedence over the By-Laws and applicable rules and regulations; and the By-Laws shall take precedence over applicable rules and regulations, all as amended from time to time. Notwithstanding anything in this Declaration, its exhibits or the Master Covenants to the contrary, the Association shall at all times be the entity having ultimate control over the Condominium, consistent with the Act and nothing contained in the Master Covenants shall conflict with the powers and duties of the Association or the rights of the Unit Owners as provided in the Act.

- 11.2 Limitation Upon Liability of Association. Notwithstanding the duty of the Association to maintain and repair parts of the Condominium Property, the Association shall not be liable to Unit Owners for injury or damage, other than for the cost of maintenance and repair, caused by any latent condition of the Condominium Property. Further, the Association shall not be liable for any such injury or damage caused by defects in design or workmanship or any other reason connected with any additions, alterations or improvements or other activities done by or on behalf of any Unit Owners regardless of whether or not same shall have been approved by the Association pursuant to Section 9 hereof. The Association also shall not be liable to any Unit Owner or lessee or to any other person or entity for any property damage, personal injury, death or other liability on the grounds that the Association did not obtain or maintain insurance (or carried insurance with any particular deductible amount) for any particular matter where: (i) such insurance is not required hereby; or (ii) the Association could not obtain such insurance at reasonable costs or upon reasonable terms. Notwithstanding the foregoing, nothing contained herein shall relieve the Association of its duty of ordinary care, as established by the Act, in carrying out the powers and duties set forth herein, nor deprive Unit Owners of their right to sue the Association if it negligently or willfully causes damage to the Unit Owner's property during the performance of its duties hereunder. The limitations upon liability of the Association described in this Subsection 11.2 are subject to the provisions of Section 718.111(3) F.S.
- 11.3 Restraint Upon Assignment of Shares in Assets. The share of a Unit Owner in the funds and assets of the Association cannot be assigned, hypothecated or transferred in any manner except as an appurtenance to his or her Unit.
- 11.4 Approval or Disapproval of Matters. Whenever the decision of a Unit Owner is required upon any matter, whether or not the subject of an Association meeting, that decision shall be expressed by the same person who would cast the vote for that Unit if at an Association meeting, unless the joinder of all record Owners of the Unit is specifically required by this Declaration or by law.
- 11.5 Acts of the Association. Unless the approval or action of Unit Owners, and/or a certain specific percentage of the Board of Directors of the Association, is specifically required in this Declaration, the Articles of Incorporation or By-Laws of the Association, applicable rules and regulations or applicable law, all approvals or actions required or permitted to be given or taken by the Association shall be given or taken by the Board of Directors, without the consent of Unit Owners, and the Board may so approve and act through the proper officers of the Association without a specific resolution. When an approval or action of the Association is permitted to be given or taken hereunder or thereunder, such action or approval may be conditioned in any manner the Association

deems appropriate or the Association may refuse to take or give such action or approval without the necessity of establishing the reasonableness of such conditions or refusal.

11.6 Effect on Developer. So long as Developer holds a Unit for sale in the ordinary course of business, none of the following actions may be taken by the Association (subsequent to control thereof being assumed by Unit Owners other than the Developer) without the prior written approval of the Developer:

- (a) Assessment of the Developer as a Unit Owner for capital improvements; or
- (b) Any action by the Association that would be detrimental to the sales of Units by the Developer or the assignment of Limited Common Elements by the Developer for consideration; provided, however, that an increase in Assessments for Common Expenses without discrimination against the Developer shall not be deemed to be detrimental to the sales of Units.

12. Determination of Common Expenses and Fixing of Assessments Therefor. The Board of Directors shall from time to time, and at least annually, prepare a budget for the Condominium and the Association, determine the amount of Assessments payable by the Unit Owners to meet the Common Expenses and allocate and assess such expenses among the Unit Owners in accordance with the provisions of this Declaration and the By-Laws. The Board of Directors shall advise all Unit Owners promptly in writing of the amount of the Assessments payable by each of them as determined by the Board of Directors as aforesaid and shall furnish copies of the budget, on which such Assessments are based, to all Unit Owners and (if requested in writing) to their respective mortgagees. The Common Expenses shall include the expenses of and reserves for (if required by, and not waived in accordance with, applicable law) the operation, maintenance, repair and replacement of the Common Elements and Association Property, costs of carrying out the powers and duties of the Association and any other expenses designated as Common Expenses by the Act, this Declaration, the Articles or By-Laws of the Association, applicable rules and regulations or by the Association. Incidental income to the Association, if any, may be used to pay regular or extraordinary Association expenses and liabilities, to fund reserve accounts, or otherwise as the Board shall determine from time to time, and need not be restricted or accumulated. Any Budget adopted shall be subject to change to cover actual expenses at any time. Any such change shall be adopted consistent with the provisions of this Declaration and the By-Laws.

13. Collection of Assessments.

13.1 Liability for Assessments. A Unit Owner, regardless of how title is acquired, including by purchase at a foreclosure sale or by deed in lieu of foreclosure shall be liable for all Assessments coming due while he or she is the Unit Owner. Additionally, a Unit Owner shall be jointly and severally liable with the previous Owner for all unpaid Assessments that came due up to the time of the conveyance, without prejudice to any right the Owner may have to recover from the previous Owner the amounts paid by the grantee Owner. The liability for Assessments may not be avoided by waiver of the use or enjoyment of any Common Elements or by the abandonment of the Unit for which the Assessments are made or otherwise.

13.2 Special and Capital Improvement Assessments. In addition to Assessments levied by the Association to meet the Common Expenses of the Condominium and the Association, the Board of Directors may levy "Special Assessments" and "Capital Improvement Assessments" upon the following terms and conditions:

- (a) "Special Assessments" shall mean and refer to an Assessment against each Owner and his or her Unit, representing a portion of the costs incurred by the Association for specific purposes of a nonrecurring nature which are not in the nature of capital improvements.

- (b) "Capital Improvement Assessments" shall mean and refer to an Assessment against each Owner and his or her Unit, representing a portion of the costs incurred by the Association for the acquisition, installation, construction or replacement (as distinguished from repairs and maintenance) of any capital improvements located or to be located within the Common Elements or Association Property.
- (c) Special Assessments and Capital Improvement Assessments may be levied by the Board and shall be payable in lump sums or installments, in the discretion of the Board; provided that, if such Special Assessments or Capital Improvement Assessments, in the aggregate in any year, exceed the Threshold Amount, the Board must obtain approval of a majority of the voting interests represented at a meeting at which a quorum is attained.

13.3 Default in Payment of Assessments for Common Expenses. Assessments and installments thereof not paid within ten (10) days from the date when they are due shall bear interest at fifteen percent (15%) per annum from the date due until paid and shall be subject to an administrative late fee in an amount not to exceed the greater of \$25.00 or five percent (5%) of each delinquent installment. The Association has a lien on each Condominium Parcel to secure the payment of Assessments. Except as set forth below, the lien is effective from, and shall relate back to, the date of the recording of this Declaration. However, as to a first mortgage of record, the lien is effective from and after the date of the recording of a claim of lien in the Public Records of the County, stating the description of the Condominium Parcel, the name of the record Owner and the name and address of the Association. The lien shall be evidenced by the recording of a claim of lien in the Public Records of the County. To be valid, the claim of lien must state the description of the Condominium Parcel, the name of the record Owner, the name and address of the Association, the amount due and the due dates, and the claim of lien must be executed and acknowledged by an officer or authorized officer of the Association. The claim of lien shall not be released until all sums secured by it (or such other amount as to which the Association shall agree by way of settlement) have been fully paid or until it is barred by law. No such lien shall be effective longer than one (1) year after the claim of lien has been recorded unless, within that one (1) year period, an action to enforce the lien is commenced. The one (1) year period shall automatically be extended for any length of time during which the Association is prevented from filing a foreclosure action by an automatic stay resulting from a bankruptcy petition filed by the Owner or any other person claiming an interest in the Unit. The claim of lien shall secure (whether or not stated therein) all unpaid Assessments, which are due and which may accrue subsequent to the recording of the claim of lien and prior to the entry of a certificate of title, as well as interest and all reasonable costs and attorneys' fees incurred by the Association incident to the collection process. Upon payment in full, the person making the payment is entitled to a satisfaction of the lien in recordable form. The Association may bring an action in its name to foreclose a lien for unpaid Assessments in the manner a mortgage of real property is foreclosed and may also bring an action at law to recover a money judgment for the unpaid Assessments without waiving any claim of lien. The Association is entitled to recover its reasonable attorneys' fees incurred either in a lien foreclosure action or an action to recover a money judgment for unpaid Assessments.

As an additional right and remedy of the Association, upon default in the payment of Assessments as aforesaid and after thirty (30) days' prior written notice to the applicable Unit Owner and the recording of a claim of lien, the Association may accelerate and declare immediately due and payable all installments of Assessments for the remainder of the fiscal year. In the event that the amount of such installments changes during the remainder of the fiscal year, the Unit Owner or the Association, as appropriate, shall be obligated to pay or reimburse to the other the amount of increase or decrease within ten (10) days of same taking effect.

- 13.4 Notice of Intention to Foreclose Lien. No foreclosure judgment may be entered until at least thirty (30) days after the Association gives written notice to the Unit Owner of its intention to foreclose its lien to collect the unpaid Assessments. If this notice is not given at least thirty (30) days before the foreclosure action is filed, and if the unpaid Assessments, including those coming due after the claim of lien is recorded, are paid before the entry of a final judgment of foreclosure, the Association shall not recover attorney's fees or costs. The notice must be given by delivery of a copy of it to the Unit Owner or by certified or registered mail, return receipt requested, addressed to the Unit Owner at the last known address, and upon such mailing, the notice shall be deemed to have been given. If after diligent search and inquiry the Association cannot find the Unit Owner or a mailing address at which the Unit Owner will receive the notice, the court may proceed with the foreclosure action and may award attorney's fees and costs as permitted by law. The notice requirements of this Subsection are satisfied if the Unit Owner records a Notice of Contest of Lien as provided in the Act.
- 13.5 Appointment of Receiver to Collect Rental. If the Unit Owner remains in possession of the Unit after a foreclosure judgment has been entered, the court in its discretion may require the Unit Owner to pay a reasonable rental for the Unit. If the Unit is rented or leased during the pendency of the foreclosure action, the Association is entitled to the appointment of a receiver to collect the rent. The expenses of such receiver shall be paid by the party which does not prevail in the foreclosure action.
- 13.6 First Mortgagee. The liability of the holder of a first mortgage on a Unit (each, a "First Mortgagee"), or its successors or assigns, who acquires title to a Unit by foreclosure or by deed in lieu of foreclosure for the unpaid Assessments (or installments thereof) that became due prior to the First Mortgagee's acquisition of title is limited to the lesser of:
- (a) The Unit's unpaid Common Expenses and regular periodic Assessments which accrued or came due during the six (6) months immediately preceding the acquisition of title and for which payment in full has not been received by the Association; or
  - (b) One percent (1%) of the original mortgage debt.

As to a Unit acquired by foreclosure, the limitations set forth in clauses (a) and (b) above shall not apply unless the First Mortgagee joined the Association as a defendant in the foreclosure action. Joinder of the Association, however, is not required if, on the date the complaint is filed, the Association was dissolved or did not maintain an office or agent for service of process at a location which was known to or reasonably discoverable by the mortgagee.

A First Mortgagee acquiring title to a Unit as a result of foreclosure or deed in lieu thereof may not, during the period of its ownership of such Unit, whether or not such Unit is unoccupied, be excused from the payment of any of the Common Expenses coming due during the period of such ownership.

- 13.7 Developer's Liability for Assessments. During the period from the date of the recording of this Declaration until the earlier of the following dates (the "Guarantee Expiration Date"): (a) the last day of the sixth (6<sup>th</sup>) full calendar month following the recording of this Declaration, or (b) the date that control of the Association is transferred to Unit Owners other than the Developer as provided in the By-Laws and the Act, the Developer shall not be obligated to pay the share of Common Expenses and Assessments attributable to the Units owned thereby, provided: (i) that the regular Assessments for Common Expenses imposed on each Unit Owner other than the Developer prior to the Guarantee Expiration Date shall not increase during such period over the amounts set forth on **Exhibit "6"** attached hereto; and (ii) that the Developer shall be obligated to pay any amount of Common Expenses actually incurred during such period and not produced by the Assessments at the guaranteed levels receivable from other Unit Owners. After

the Guarantee Expiration Date, the Developer shall have the option, in its sole discretion, of extending the guarantee for up to eight (8) additional six (6) month periods, or paying the share of Common Expenses and Assessments attributable to Units it then owns.

Notwithstanding the above and as provided in Section 718.116(9)(a)(2) of the Act, in the event of an Extraordinary Financial Event (as hereinafter defined), the costs necessary to effect restoration shall be assessed against all Unit Owners owning units on the date of such Extraordinary Financial Event, and their successors and assigns, including the Developer (with respect to Units owned by the Developer). As used in this Subsection, an "Extraordinary Financial Event" shall mean Common Expenses incurred prior to the Guarantee Expiration Date (as same may be extended) resulting from a natural disaster or Act of God, which is not covered by insurance proceeds from the insurance maintained by the Association as required by Section 718.111(11)(a) of the Act.

- 13.8 Estoppel Statement. Within fifteen (15) days after receiving a written request therefor from a purchaser, Unit Owner or mortgagee of a Unit, the Association shall provide a certificate, signed by an officer or agent of the Association, stating all Assessments and other moneys owed to the Association by the Unit Owner with respect to his or her Unit. Any person other than the Unit Owner who relies upon such certificate shall be protected thereby. The Association or its authorized agent may charge a reasonable fee for the preparation of such certificate.
- 13.9 Installments. Regular Assessments shall be collected monthly or quarterly, in advance, at the option of the Association. Initially, assessments will be collected monthly.
- 13.10 Application of Payments. Any payments received by the Association from a delinquent Unit Owner shall be applied first to any interest accrued on the delinquent installment(s) as aforesaid, then to any administrative late fees, then to any costs and reasonable attorneys' fees incurred in collection and then to the delinquent and any accelerated Assessments. The foregoing shall be applicable notwithstanding any restrictive endorsement, designation or instruction placed on or accompanying a payment.
14. Insurance. Insurance covering the Condominium Property and the Association Property shall be governed by the following provisions:
- 14.1 Purchase, Custody and Payment.
- (a) Purchase. Subject to the provisions of the Master Covenants, all insurance policies described herein covering portions of the Condominium and Association Property shall be purchased by the Association and shall be issued by an insurance company authorized to do business in Florida or by a surplus lines carrier offering policies for Florida properties reasonably acceptable to the Board.
- (b) Approval. Each insurance policy, the agency and company issuing the policy and the Insurance Trustee (if appointed) hereinafter described shall be subject to the approval of the Primary Institutional First Mortgagee in the first instance, if requested thereby.
- (c) Named Insured. The named insured shall be the Association, individually, and as agent for Owners of Units covered by the policy, without naming them, and as agent for their mortgagees, without naming them. The Unit Owners and their mortgagees shall be deemed additional named insureds.
- (d) Custody of Policies and Payment of Proceeds. All policies shall provide that payments for losses made by the insurer shall be paid to the Association or to the Insurance Trustee (if appointed), and all policies and endorsements thereto shall be deposited with the Association or to the Insurance Trustee (if appointed).

- (e) Copies to Mortgagees. One copy of each insurance policy, or a certificate evidencing such policy, and all endorsements thereto, shall be furnished by the Association upon request to each Institutional First Mortgagee who holds a mortgage upon a Unit covered by the policy. Copies or certificates shall be furnished not less than ten (10) days prior to the beginning of the term of the policy, or not less than ten (10) days prior to the expiration of each preceding policy that is being renewed or replaced, as appropriate.
- (f) Personal Property and Liability. Except as specifically provided herein or by the Act, the Association shall not be responsible to Unit Owners to obtain insurance coverage upon the property lying within the boundaries of their Unit, including, but not limited to, their personal property, and for their personal liability, moving and relocation expenses, lost rent expenses and living expenses and for any other risks not otherwise insured in accordance herewith. To the extent that a Unit Owner or other occupant of a Unit desires coverage for such excluded items, it shall be the sole responsibility of the Unit Owner and/or occupant to obtain.

14.2 Coverage. The Association shall maintain insurance covering the following:

- (a) Casualty. The Insured Property (as hereinafter defined) shall be insured in an amount not less than 100% of the full insurable replacement value thereof, excluding foundation and excavation costs (and subject to such reasonable deductibles as discussed below). The policy shall provide primary coverage for the following (the "Insured Property"): (i) all portions of the Condominium Property located outside the Units, (ii) the Condominium Property located inside the Units as such property was initially installed, or replacements thereof of like kind and quality and in accordance with the original plans and specifications or, if the original plans and specifications are not available, as they existed at the time that the Unit was initially conveyed, and (iii) the Building (including all fixtures, installations or additions comprising that part of the Building within the boundaries of the Units and required by the Act to be insured under the Association's policies) and all Improvements located on the Common Elements and the Association Property from time to time, together with all fixtures, building service equipment, personal property and supplies constituting the Common Elements or Association Property. Notwithstanding the foregoing, the Insured Property shall not include, and shall specifically exclude, all floor, wall and ceiling coverings, furniture and furnishings, electrical fixtures, appliances, air conditioner and/or heating equipment, water heaters, water filters, built-in cabinets and countertops, and window treatments, including curtains, drapes, blinds, hardware and similar window treatment components, or replacements of any of the foregoing which are located within the boundaries of a Unit and serve only one Unit and all air conditioning compressors that service only an individual Unit, if any, whether or not located within the Unit boundaries. Such policies may contain reasonable deductible provisions as determined by the Board of Directors of the Association. Such coverage shall afford protection against loss or damage by fire and other hazards covered by a standard extended coverage endorsement, and such other risks as from time to time are customarily covered with respect to buildings and improvements similar to the Insured Property in construction, location and use, including, but not limited to, vandalism and malicious mischief.
- (b) Liability. Comprehensive general public liability and automobile liability insurance covering loss or damage resulting from accidents or occurrences on or about or in connection with the Insured Property or adjoining driveways and walkways, subject to this Declaration, or any work, matters or things related to the Insured Property, with such coverage as shall be required by the Board of Directors of the Association, but with combined single limit liability of not less than \$1,000,000 for each accident or occurrence, \$100,000 per person and

\$50,000 property damage, and with a cross liability endorsement to cover liabilities of the Unit Owners as a group to any Unit Owner, and vice versa. The Association may also obtain and maintain liability insurance for its directors and officers and for the benefit of the Association's employees, in such amounts and under such terms and conditions as the Association deems appropriate in its sole and absolute discretion.

- (c) Worker's Compensation and other mandatory insurance, when applicable.
- (d) Flood Insurance covering the Common Elements, Association Property and Units if required by the Primary Institutional First Mortgagee or FNMA/FHLMC, or if the Association so elects.
- (e) Errors and Omissions. The Association shall obtain and maintain adequate liability, errors and omission coverage on behalf of each of the officers and directors of the Association.
- (f) Fidelity Insurance or Fidelity Bonds. The Association shall obtain and maintain adequate insurance or fidelity bonding of all persons who control or disburse Association funds which shall include, without limitation, those individuals authorized to sign Association checks and the president, secretary and treasurer of the Association. The insurance policy or fidelity bond shall be in such amount as shall be determined by a majority of the Board, but must be sufficient to cover the maximum funds that will be in the custody of the Association or its management agent at any one time. The premiums on such bonds and/or insurance shall be paid by the Association as a Common Expense.
- (g) Association Property. Appropriate additional policy provisions, policies or endorsements extending the applicable portions of the coverage described above to all Association Property, where such coverage is available.
- (h) Such Other Insurance as the Board of Directors of the Association shall determine from time to time to be desirable.

When appropriate and obtainable, each of the foregoing policies shall waive the insurer's right to: (i) subrogation against the Association and against the Unit Owners individually and as a group, (ii) pay only a fraction of any loss in the event of coinsurance or if other insurance carriers have issued coverage upon the same risk, and (iii) avoid liability for a loss that is caused by an act of the Board of Directors of the Association, a member of the Board of Directors of the Association, one or more Unit Owners or as a result of contractual undertakings. Additionally, each policy shall provide that any insurance trust agreement will be recognized, that the insurance provided shall not be prejudiced by any act or omissions of individual Unit Owners that are not under the control of the Association, and that the policy shall be primary, even if a Unit Owner has other insurance that covers the same loss.

Every casualty insurance policy obtained by the Association, if required by FNMA/FHLMC, and if generally available, shall have the following endorsements: (i) agreed amount and inflation guard and (ii) steam boiler coverage (providing at least \$50,000.00 coverage), if applicable.

- 14.3 Additional Provisions. All policies of insurance shall provide that such policies may not be canceled or substantially modified without at least thirty (30) days' prior written notice to all of the named insureds, including all mortgagees of Units. Prior to obtaining any policy of casualty insurance or any renewal thereof, the Board of Directors may (or if required by FNMA/FHLMC, shall) obtain an appraisal from a fire insurance company, or other competent insurance appraiser, of the full insurable replacement value of the Insured Property (exclusive of foundations), without deduction for depreciation, for the



purpose of determining the amount of insurance to be effected pursuant to this Section 14.

- 14.4 Premiums. Premiums upon insurance policies purchased by the Association shall be paid by the Association as a Common Expense, except that the costs of fidelity bonding for any management company employee may be paid by such company pursuant to its contract with the Association. Premiums may be financed in such manner as the Board of Directors deems appropriate. The Board shall determine the appropriate deductible for each policy of insurance, including, without limitation, the deductible for windstorm insurance which may be a substantial amount. Each Owner, by acceptance of a deed or other conveyance of a Unit, hereby ratifies and confirms any decisions made by the Association in this regard and recognizes and agrees that funds to cover the deductible must be provided from the general operating funds of the Association before the Association will be entitled to insurance proceeds. The Association may, but shall not be obligated to, establish a reserve to cover any applicable deductible.
- 14.5 Insurance Trustee or Association; Share of Proceeds. If an Insurance Trustee has not been appointed by the Association, then the Association is hereby irrevocably appointed as an agent and attorney-in-fact for each and every Unit Owner, for each Institutional First Mortgagee and/or each owner of any other interest in the Condominium Property to adjust and settle any and all claims arising under any insurance policy purchased by the Association and to execute and deliver releases upon the payment of claims, if any. The decision to engage or appoint an Insurance Trustee, or not to do so, lies solely with the Association. All insurance policies obtained by or on behalf of the Association shall be for the benefit of the Association, the Unit Owners and their mortgagees, as their respective interests may appear, and shall provide that all proceeds covering property losses shall be paid to the Association or to the Insurance Trustee, if one is appointed by the Association, which may be designated by the Board of Directors as provided in Subsection 14.10 below and in this Subsection 14.5, and which, if so appointed, shall be a bank or trust company in Florida with trust powers, with its principal place of business in the State of Florida. The Insurance Trustee shall not be liable for payment of premiums, or for the renewal or the sufficiency of policies, nor for the failure to collect any insurance proceeds. The duty of the Insurance Trustee or the Association, as applicable, shall be to receive such proceeds as are paid and to hold the same in trust for the purposes elsewhere stated herein, and for the benefit of the Unit Owners and their respective mortgagees in the following shares, but shares need not be set forth on the records of the Insurance Trustee:
- (a) Insured Property. Proceeds on account of damage to the Insured Property shall be held in undivided shares for each Unit Owner, such shares being the same as the undivided shares in the Common Elements appurtenant to each Unit, provided that if the Insured Property so damaged includes property lying within the boundaries of specific Units, that portion of the proceeds allocable to such property shall be held as if that portion of the Insured Property were Optional Property as described in paragraph (b) below.
  - (b) Optional Property. Proceeds on account of damage solely to Units and/or certain portions or all of the contents thereof not included in the Insured Property (all as determined by the Association in its sole discretion) (collectively the "Optional Property"), if any is collected by reason of optional insurance which the Association elects to carry thereon (as contemplated herein), shall be held for the benefit of Owners of Units or other portions of the Optional Property damaged in proportion to the cost of repairing the damage suffered by each such affected Owner, which cost and allocation shall be determined in the sole discretion of the Association.
  - (c) Mortgagees. No mortgagee shall have any right to determine or participate in the determination as to whether or not any damaged property shall be reconstructed

or repaired, and no mortgagee shall have any right to apply or have applied to the reduction of a mortgage debt any insurance proceeds, except for actual distributions thereof made to the Unit Owner and mortgagee pursuant to the provisions of this Declaration.

- 14.6 Distribution of Proceeds. Proceeds of insurance policies received by the Association and/or Insurance Trustee, as applicable, shall be distributed to or for the benefit of the beneficial owners thereof in the following manner:
- (a) Expenses of the Trustee. All expenses of the Insurance Trustee (if any) shall be first paid or provision shall be made therefor.
  - (b) Reconstruction or Repair. If the damaged property for which the proceeds are paid is to be repaired or reconstructed, the remaining proceeds shall be paid to defray the cost thereof as elsewhere provided herein. Any proceeds remaining after defraying such costs shall be distributed to the beneficial owners thereof, remittances to Unit Owners and their mortgagees being payable jointly to them.
  - (c) Failure to Reconstruct or Repair. If it is determined in the manner elsewhere provided that the damaged property for which the proceeds are paid shall not be reconstructed or repaired, the remaining proceeds shall be allocated among the beneficial owners as provided in Subsection 14.5 above, and distributed first to all Institutional First Mortgagees in an amount sufficient to pay off their mortgages, and the balance, if any, to the beneficial owners.
  - (d) Certificate. In making distributions to Unit Owners and their mortgagees, the Insurance Trustee (if appointed) may rely upon a certificate of the Association made by its President and Secretary as to the names of the Unit Owners and their mortgagees and their respective shares of the distribution.
- 14.7 Association as Agent. The Association is hereby irrevocably appointed as agent and attorney-in-fact for each Unit Owner and for each owner of a mortgage or other lien upon a Unit and for each owner of any other interest in the Condominium Property to adjust all claims arising under insurance policies purchased by the Association and to execute and deliver releases upon the payment of claims.
- 14.8 Unit Owners' Personal Coverage. Unless the Association elects otherwise, the insurance purchased by the Association shall not cover claims against an Owner due to accidents occurring within his or her Unit, nor casualty or theft loss to the contents of an Owner's Unit. It shall be the obligation of the individual Unit Owner, if such Owner so desires, to purchase and pay for insurance as to all such and other risks not covered by insurance carried by the Association.
- 14.9 Benefit of Mortgagees. Certain provisions in this Section 14 are for the benefit of mortgagees of Units and may be enforced by such mortgagees.
- 14.10 Appointment of Insurance Trustee. The Board of Directors of the Association shall have the option in its discretion of appointing an Insurance Trustee hereunder. If the Association fails or elects not to appoint such Trustee, the Association, pursuant to Subsection 14.5 above, will perform directly all obligations imposed upon such Trustee by this Declaration. Fees and expenses of any Insurance Trustee are Common Expenses.
- 14.11 Presumption as to Damaged Property. In the event of a dispute or lack of certainty as to whether damaged property constitutes a Unit(s) or Common Elements, such property shall be presumed to be Common Elements.

15. Reconstruction or Repair After Fire or Other Casualty.

- 15.1 Determination to Reconstruct or Repair. Subject to the provisions of the Master Covenants and the immediately following paragraphs, in the event of damage to or destruction of the Insured Property (and the Optional Property, if insurance has been obtained by the Association with respect thereto) as a result of fire or other casualty, the Board of Directors shall arrange for the prompt repair and restoration of the Insured Property (and the Optional Property, if insurance has been obtained by the Association with respect thereto) and the Association and/or Insurance Trustee (if appointed), as applicable, shall disburse the proceeds of all insurance policies to the contractors engaged in such repair and restoration in appropriate progress payments.

If 75% or more of the Insured Property (and the Optional Property, if insurance has been obtained by the Association with respect thereto) is substantially damaged or destroyed and if Unit Owners owning 80% of the applicable interests in the Common Elements duly and promptly resolve not to proceed with the repair or restoration thereof and a Majority of Institutional First Mortgagees approve such resolution, the Condominium Property will not be repaired and shall be subject to an action for partition instituted by the Association, any Unit Owner, mortgagee or lienor, as if the Condominium Property were owned in common, in which event the net proceeds of insurance resulting from such damage or destruction shall be divided among all the Unit Owners in proportion to their respective interests in the Common Elements (with respect to proceeds held for damage to the Insured Property other than that portion of the Insured Property lying within the boundaries of the Unit), and among affected Unit Owners in proportion to the damage suffered by each such affected Unit Owner, as determined in the sole discretion of the Association (with respect to proceeds held for damage to the Optional Property, if any, and/or that portion of the Insured Property lying within the boundaries of the Unit); provided, however, that no payment shall be made to a Unit Owner until there has first been paid off out of his or her share of such fund all mortgages and liens on his or her Unit in the order of priority of such mortgages and liens.

Whenever in this Section the words "promptly repair" are used, it shall mean that repairs are to begin not more than sixty (60) days from the date the Association holds, or the Insurance Trustee (if appointed) notifies the Board of Directors and Unit Owners that it holds, proceeds of insurance on account of such damage or destruction sufficient to pay the estimated cost of such work, or not more than ninety (90) days after the Association determines that, or the Insurance Trustee (if appointed) notifies the Board of Directors and the Unit Owners that, such proceeds of insurance are insufficient to pay the estimated costs of such work. The Insurance Trustee (if appointed) may rely upon a certificate of the Association made by its President and Secretary to determine whether or not the damaged property is to be reconstructed or repaired.

- 15.2 Plans and Specifications. Any reconstruction or repair must be made substantially in accordance with the plans and specifications for the original Improvements and then applicable building and other codes; or if not, then in accordance with the plans and specifications approved by the Board of Directors of the Association and then applicable building and other codes, and, if the damaged property which is to be altered is the Building or the Optional Property, by the Owners of not less than 80% of the applicable interests in the Common Elements, as well as the Owners of all Units and other portions of the Optional Property (and their respective mortgagees) the plans for which are to be altered.
- 15.3 Special Responsibility. If the damage is only to those parts of the Optional Property for which the responsibility of maintenance and repair is that of the respective Unit Owners, then the Unit Owners shall be responsible for all necessary reconstruction and repair, which shall be effected promptly and in accordance with guidelines established by the Board of Directors (unless insurance proceeds are held by the Association with respect thereto by reason of the purchase of optional insurance thereon, in which case the

Association shall have the responsibility to reconstruct and repair the damaged Optional Property, provided the respective Unit Owners shall be individually responsible for any amount by which the cost of such repair or reconstruction exceeds the insurance proceeds held for such repair or reconstruction on a Unit by Unit basis, as determined in the sole discretion of the Association). In all other instances, the responsibility for all necessary reconstruction and repair shall be that of the Association.

- (a) Disbursement. The proceeds of insurance collected on account of a casualty, and the sums collected from Unit Owners on account of such casualty, shall constitute a construction fund which shall be disbursed in payment of the costs of reconstruction and repair in the following manner and order:
- (i) Association - Lesser Damage. If the amount of the estimated costs of reconstruction and repair which are the responsibility of the Association is less than \$100,000, then the construction fund shall be disbursed in payment of such costs upon the order of the Board of Directors of the Association; provided, however, that upon request to the Insurance Trustee (if appointed) by an Institutional First Mortgagee which is a beneficiary of an insurance policy, the proceeds of which are included in the construction fund, such fund shall be disbursed in the manner provided below for the reconstruction and repair of major damage.
  - (ii) Association - Major Damage. If the amount of the estimated costs of reconstruction and repair which are the responsibility of the Association is more than \$100,000, then the construction fund shall be disbursed in payment of such costs in the manner contemplated by Subsection 15.3(a)(i) above, but then only upon the further approval of an architect or engineer qualified to practice in Florida and employed by the Association to supervise the work.
  - (iii) Unit Owners. If there is a balance of insurance proceeds after payment of all costs of reconstruction and repair that are the responsibility of the Association, this balance may be used by the Association to effect repairs to the Optional Property (if not insured or if under-insured), or may be distributed to Owners of the Optional Property who have the responsibility for reconstruction and repair thereof. The distribution shall be in the proportion that the estimated cost of reconstruction and repair of such damage to each affected Unit Owner bears to the total of such estimated costs to all affected Unit Owners, as determined by the Board; provided, however, that no Unit Owner shall be paid an amount in excess of the estimated costs of repair for his or her portion of the Optional Property. Any and all proceeds shall only be used to effect repairs to the Optional Property, and if insufficient to complete such repairs, the Owners shall pay the deficit with respect to their portion of the Optional Property and promptly effect the repairs. Any balance remaining after such repairs have been effected shall be distributed to the affected Unit Owners and their mortgagees jointly as elsewhere herein contemplated.
  - (iv) Surplus. It shall be presumed that the first monies disbursed in payment of costs of reconstruction and repair shall be from insurance proceeds. If there is a balance in a construction fund after payment of all costs relating to the reconstruction and repair for which the fund is established, such balance shall be distributed to the beneficial owners of the fund in the manner elsewhere stated; except, however, that part of a distribution to an Owner which is not in excess of Assessments paid by such Owner into the construction fund shall not be made payable jointly to any mortgagee.

- (v) Certificate. Notwithstanding the provisions herein, the Insurance Trustee shall not be required to determine whether or not sums paid by Unit Owners upon Assessments shall be deposited by the Association with the Insurance Trustee, nor to determine whether the disbursements from the construction fund are to be made upon the order of the Association alone or upon the additional approval of an architect, engineer or otherwise, nor whether a disbursement is to be made from the construction fund, nor to determine whether surplus funds to be distributed are less than the Assessments paid by Owners, nor to determine the payees nor the amounts to be paid. The Insurance Trustee may rely upon a certificate of the Association, made by its President and Secretary, as to any or all of such matters and stating that the sums to be paid are due and properly payable, and stating the names of the payees and the amounts to be paid.
- 15.4 Assessments. If the proceeds of the insurance are not sufficient to defray the estimated costs of reconstruction and repair to be effected by the Association, or if at any time during reconstruction and repair, or upon completion of reconstruction and repair, the funds for the payment of the costs of reconstruction and repair are insufficient, Assessments shall be made against the Unit Owners in sufficient amounts to provide funds for the payment of such costs. Such Assessments on account of damage to the Insured Property shall be in proportion to all of the Owners' respective shares in the Common Elements, and on account of damage to the Optional Property, the Association shall charge the Owner (but shall not levy an Assessment) in proportion to the cost of repairing the damage suffered by each Owner thereof, as determined by the Association.
- 15.5 Benefit of Mortgagees. Certain provisions in this Section 15 are for the benefit of mortgagees of Units and may be enforced by any of them.
16. Condemnation.
- 16.1 Deposit of Awards with Insurance Trustee. The taking of portions of the Condominium Property or Association Property by the exercise of the power of eminent domain shall be deemed to be a casualty, and the awards for that taking shall be deemed to be proceeds from insurance on account of the casualty and shall be deposited with the Insurance Trustee. Even though the awards may be payable to Unit Owners, the Unit Owners shall deposit the awards with the Insurance Trustee; and in the event of failure to do so, in the discretion of the Board of Directors of the Association, a Charge shall be made against a defaulting Unit Owner in the amount of his or her award, or the amount of that award shall be set off against the sums hereafter made payable to that Owner.
- 16.2 Determination Whether to Continue Condominium. Whether the Condominium will be continued after condemnation will be determined in the manner provided for determining whether damaged property will be reconstructed and repaired after casualty. For this purpose, the taking by eminent domain also shall be deemed to be a casualty.
- 16.3 Disbursement of Funds. If the Condominium is terminated after condemnation, the proceeds of the awards and special Assessments will be deemed to be insurance proceeds and shall be owned and distributed in the manner provided with respect to the ownership and distribution of insurance proceeds if the Condominium is terminated after a casualty. If the Condominium is not terminated after condemnation, the size of the Condominium will be reduced and the property damaged by the taking will be made usable in the manner provided below. The proceeds of the awards and special Assessments shall be used for these purposes and shall be disbursed in the manner provided for disbursement of funds by the Insurance Trustee (if appointed) after a casualty, or as elsewhere in this Section 16 specifically provided.
- 16.4 Unit Reduced but Habitable. If the taking reduces the size of a Unit and the remaining portion of the Unit can be made habitable (in the sole opinion of the Association), the

award for the taking of a portion of the Unit shall be used for the following purposes in the order stated and the following changes shall be made to the Condominium:

- (a) Restoration of Unit. The Unit shall be made habitable. If the cost of the restoration exceeds the amount of the award, the additional funds required shall be charged to and paid by the Owner of the Unit.
- (b) Distribution of Surplus. The balance of the award in respect of the Unit, if any, shall be distributed to the Owner of the Unit and to each mortgagee of the Unit, the remittance being made payable jointly to the Owner and such mortgagees.
- (c) Adjustment of Shares in Common Elements. If the floor area of the Unit is reduced by the taking, the percentage representing the share in the Common Elements and of the Common Expenses and Common Surplus appurtenant to the Unit shall be reduced by multiplying the percentage of the applicable Unit prior to reduction by a fraction, the numerator of which shall be the area in square feet of the Unit after the taking and the denominator of which shall be the area in square feet of the Unit before the taking. The shares of all Unit Owners in the Common Elements, Common Expenses and Common Surplus shall then be restated as follows:
  - (i) add the total of all percentages of all Units after reduction as aforesaid (the "Remaining Percentage Balance"); and
  - (ii) divide each percentage for each Unit after reduction as aforesaid by the Remaining Percentage Balance.

The result of such division for each Unit shall be the adjusted percentage for such Unit.

16.5 Unit Made Uninhabitable. If the taking is of the entire Unit or so reduces the size of a Unit that it cannot be made habitable (in the sole opinion of the Association), the award for the taking of the Unit shall be used for the following purposes in the order stated and the following changes shall be made to the Condominium:

- (a) Payment of Award. The awards shall be paid first to the applicable Institutional First Mortgagees in amounts sufficient to pay off their mortgages in connection with each Unit which is not so habitable; second, to the Association for any due and unpaid Assessments; third, jointly to the affected Unit Owners and other mortgagees of their Units. In no event shall the total of such distributions in respect of a specific Unit exceed the market value of such Unit immediately prior to the taking. The balance, if any, shall be applied to repairing and replacing the Common Elements.
- (b) Addition to Common Elements. The remaining portion of the Unit, if any, shall become part of the Common Elements and shall be placed in a condition allowing, to the extent possible, for use by all of the Unit Owners in the manner approved by the Board of Directors of the Association; provided that if the cost of the work therefor shall exceed the balance of the fund from the award for the taking, such work shall be approved in the manner elsewhere required for capital improvements to the Common Elements.
- (c) Adjustment of Shares. The shares in the Common Elements, Common Expenses and Common Surplus appurtenant to the Units that continue as part of the Condominium shall be adjusted to distribute the shares in the Common Elements, Common Expenses and Common Surplus among the reduced number of Unit Owners (and among reduced Units). This shall be effected by restating the shares of continuing Unit Owners as follows:

- (i) add the total of all percentages of all Units of continuing Owners prior to this adjustment, but after any adjustments made necessary by Subsection 16.4(c) hereof (the "Percentage Balance"); and
- (ii) divide the percentage of each Unit of a continuing Owner prior to this adjustment, but after any adjustments made necessary by Subsection 16.4(c) hereof, by the Percentage Balance.

The result of such division for each Unit shall be the adjusted percentage for such Unit.

- (d) Assessments. If the balance of the award (after payments to the Unit Owner and such Owner's mortgagees as above provided) for the taking is not sufficient to alter the remaining portion of the Unit for use as a part of the Common Elements, the additional funds required for such purposes shall be raised by Assessments against all of the Unit Owners who will continue as Owners of Units after the changes in the Condominium effected by the taking. The Assessments shall be made in proportion to the applicable percentage shares of those Owners after all adjustments to such shares effected pursuant hereto by reason of the taking.
- (e) Arbitration. If the market value of a Unit prior to the taking cannot be determined by agreement between the Unit Owner and mortgagees of the Unit and the Association within 30 days after notice of a dispute by any affected party, such value shall be determined by arbitration in accordance with the then existing rules of the American Arbitration Association, except that the arbitrators shall be two appraisers appointed by the American Arbitration Association who shall base their determination upon an average of their appraisals of the Unit. A judgment upon the decision rendered by the arbitrators may be entered in any court of competent jurisdiction in accordance with the Florida Arbitration Code. The cost of arbitration proceedings shall be assessed against all Unit Owners, including Owners who will not continue after the taking, in proportion to the applicable percentage shares of such Owners as they exist prior to the adjustments to such shares effected pursuant hereto by reason of the taking. Notwithstanding the foregoing, nothing contained herein shall limit or abridge the remedies of Unit Owners provided in Sections 718.303 and 718.506, F.S.

16.6 Taking of Common Elements. Awards for the taking of Common Elements shall be used to render the remaining portion of the Common Elements usable in the manner approved by the Board of Directors of the Association; provided, that if the cost of such work shall exceed the balance of the funds from the awards for the taking, the work shall be approved in the manner elsewhere required for capital improvements to the Common Elements. The balance of the awards for the taking of Common Elements, if any, shall be distributed to the Unit Owners in the shares in which they own the Common Elements after adjustments to these shares effected pursuant hereto by reason of the taking. If there is a mortgage on a Unit, the distribution shall be paid jointly to the Owner and the mortgagees of the Unit.

16.7 Amendment of Declaration. The changes in Units, in the Common Elements and in the ownership of the Common Elements and share in the Common Expenses and Common Surplus that are effected by the taking shall be evidenced by an amendment to this Declaration of Condominium that is only required to be approved by, and executed upon the direction of, a majority of all Directors of the Association.

17. Occupancy and Use Restrictions. In order to provide for congenial occupancy of the Condominium and Association Property and for the protection of the values of the Units, the use of the Condominium Property shall be restricted to and shall be in accordance with the following provisions:

- 17.1 Occupancy. Each Unit shall be used as a residence and/or home office only, except as otherwise herein expressly provided, all in accordance with, and only to the extent permitted by, applicable City, County, state and federal codes, ordinances and regulations. Home office use of a Unit shall only be permitted to the extent permitted by law and to the extent that the office is not staffed by employees, is not used to receive clients and/or customers and does not generate additional visitors or traffic into the Unit or on any part of the Condominium Property. The provisions of this Subsection 17.1 shall not be applicable to Units used by the Developer, which it has the authority to do without Unit Owner consent or approval, and without payment of consideration, for model apartments, guest suites, sales, re-sales and/or leasing offices and/or for the provision of management construction, development and/or financial services.
- 17.2 Children. Children shall be permitted to be occupants of Units.
- 17.3 Pet Restrictions. Not more than two (2) domesticated pets may be maintained in a Unit provided such pets are: (a) permitted to be so kept by applicable laws and regulations, (b) not left unattended on porches, (c) carried at all times when on the Common Elements and/or Association Property, (d) generally, not a nuisance to residents of other Units or of neighboring buildings and (e) not a pit bull or other breed considered to be dangerous or a nuisance by the Board of Directors (in its sole and absolute discretion); provided that neither the Developer, the Board nor the Association shall be liable for any personal injury, death or property damage resulting from a violation of the foregoing and any occupant of a Unit committing such a violation shall fully indemnify and hold harmless the Board of Directors, the Developer, each Unit Owner and the Association in such regard. The following provisions shall also govern any pets on the Condominium and/or Association Property:
- (i) All pets must be on a leash not more than eight (8) feet long or carried when outside of the Unit.
  - (ii) Pets shall only be walked or taken upon those portions of the Condominium and/or Association Property designated by the Association from time to time for such purposes, if any. Under no circumstances shall pets be permitted in the pool area, on the pool deck or in the swimming pool.
  - (iii) Unit Owners shall pick up all solid wastes from their pets and dispose of same appropriately.
  - (iv) Each Owner shall be responsible for all damage caused by his/her pet.
  - (v) The maintenance, keeping, boarding and/or raising of pot belly pigs, reptiles, rodents (i.e., mice, gerbils, hamsters) and any other animals, livestock, or poultry of any kind, regardless of number, is expressly prohibited.
  - (vi) Pets may not play or exercise in the corridors, stairwells, roof, laundry rooms or other portions of the Condominium Property or Association Property, other than the Owner's Unit.
  - (vii) Each Owner agrees to underwrite the cost of necessary extermination in the Owner's Unit or others if Owner's pet is responsible for the infestation of the building or portions thereof.
  - (viii) Each Owner agrees to restrain its pet in an appropriate manner should it be requested either for cause or the result of a justifiable request from the Association (i.e., muzzled when going through public areas).
  - (ix) All cats must be spayed and declawed.



Any landscaping damage or other damage to the Common Elements caused by a Unit Owner's pet must be promptly repaired by the Unit Owner. The Association retains the right to effect said repairs and charge the Unit Owner therefor. Without limiting the generality of Section 18 hereof, a violation of the provisions of this paragraph shall entitle the Association to all of its rights and remedies, including, but not limited to, the right to fine Unit Owners (as provided in the By-Laws and any applicable rules and regulations) and/or to require any pet to be permanently removed from the Condominium Property. No pet shall be maintained in any parking space or Garage.

- 17.4 Alterations. Without limiting the generality of Subsection 9.1 hereof, but subject to Section 11 hereof, no Unit Owner shall cause or allow improvements or physical or structural changes to any Unit, Limited Common Elements appurtenant thereto, Common Elements or Association Property, including, but not limited to, installing or altering any electrical wiring or plumbing systems, installing television antennae, satellite dishes, electronic devices, transmitting and/or receiving equipment, machinery, or air-conditioning units, which in any manner change the appearance of any portion of the Building or the exterior of said Unit, without obtaining the prior written consent of the Association (in the manner specified in Subsection 9.1 hereof). Curtains, blinds, shutters, levelors, or draperies (or linings thereof) which face the exterior windows or glass doors of Units shall be white or off-white in color and shall be subject to disapproval by the Association, in which case they shall be removed and replaced by the Unit Owner with items acceptable to the Association.
- 17.5 Use of Common Elements and Association Property. The Common Elements and Association Property shall be used only for furnishing of the services and facilities for which they are reasonably suited and which are incident to the use and occupancy of Units. In that regard, each Unit Owner, by acceptance of a deed for a Unit, thereby covenants and agrees that it is the intention of the Developer that the stairwells of the Buildings are intended primarily for ingress and egress, and as such may be left unfinished solely as to be functional for said purpose, without regard to the aesthetic appearance of said stairwells. Similarly, any garage and utility pipes serving the Condominium are intended primarily for functional purposes, and as such may be left unfinished without regard to the aesthetic appearance of same.
- 17.6 Nuisances. No nuisances (as defined by the Association) shall be allowed on the Condominium or Association Property, nor shall any use or practice be allowed which is a source of annoyance to occupants of Units or which interferes with the peaceful possession or proper use of the Condominium and/or Association Property by its residents, occupants or members. No activity specifically permitted by this Declaration or the Master Covenants shall be deemed a nuisance.
- 17.7 No Improper Uses. No improper, offensive, hazardous or unlawful use shall be made of the Condominium or Association Property or any part thereof, and all valid laws, zoning ordinances and regulations of all governmental bodies having jurisdiction thereover shall be observed. Violations of laws, orders, rules, regulations or requirements of any governmental agency having jurisdiction thereover, relating to any portion of the Condominium and/or Association Property, shall be corrected by, and at the sole expense of, the party obligated to maintain or repair such portion of the Condominium Property, as elsewhere herein set forth. Notwithstanding the foregoing and any provisions of this Declaration, the Articles of Incorporation or By-Laws, the Association shall not be liable to any person(s) for its failure to enforce the provisions of this Subsection 17.7. No activity specifically permitted by this Declaration or the Master Covenants shall be deemed to be a violation of this Section 17.7.
- 17.8 Leases. No portion of a Unit (other than an entire Unit) may be rented. Leasing of Units shall not be subject to the prior written approval of the Association, however each lease shall be in writing and shall specifically provide (or, if it does not, shall be automatically deemed to provide) that a material condition of the lease shall be the tenant's full

compliance with the covenants, terms, conditions and restrictions of this Declaration (and all Exhibits hereto), the Master Covenants, and with any and all rules and regulations adopted by the Association from time to time (before or after the execution of the lease and/or any modifications, renewals or extensions of same). The Unit Owner will be jointly and severally liable with the tenant to the Association for any amount which is required by the Association to repair any damage to the Common Elements resulting from acts or omissions of tenants (as determined in the sole discretion of the Association) and to pay any claim for injury or damage to property caused by the negligence of the tenant and special Assessments may be levied against the Unit therefor. All leases are hereby made subordinate to any lien filed by the Condominium Association, whether prior or subsequent to such lease. If so required by the Association, a tenant wishing to lease a Unit shall be required to place in escrow with the Association a reasonable sum, not to exceed the equivalent of one month's rental, which may be used by the Association to repair any damage to the Common Elements and/or Association Property resulting from acts or omissions of tenants (as determined in the sole discretion of the Association). Payment of interest, claims against the deposit, refunds and disputes regarding the disposition of the deposit shall be handled in the same fashion as provided in Part II of Chapter 83, Florida Statutes. No lease of a Unit shall be for a period of less than six (6) months and no Unit may be leased more than two (2) times, including any renewals, in any calendar year (to be determined by review of the commencement dates of the applicable lease and/or renewal -- i.e., no more than two (2) leases, including renewals, of a Unit may commence in the same calendar year).

When a Unit is leased, a tenant shall have all use rights in Association Property and those Common Elements otherwise readily available for use generally by Unit Owners, and the Owner of the leased Unit shall not have such rights, except as a guest, unless such rights are waived in writing by the tenant. Nothing herein shall interfere with the access rights of the Unit Owner as a landlord pursuant to Chapter 83, Florida Statutes. The Association shall have the right to adopt rules to prohibit dual usage by a Unit Owner and a tenant of Association Property and Common Elements otherwise readily available for use generally by Owners.

The lease of a Unit for a term of six (6) months or less is subject to a tourist development tax assessed pursuant to Section 125.0104, Florida Statutes. A Unit Owner leasing his or her Unit for a term of six (6) months or less agrees, and shall be deemed to have agreed, for such Owner, and his or her heirs, personal representatives, successors and assigns, as appropriate, to hold the Association, the Developer and all other Unit Owners harmless from and to indemnify them for any and all costs, claims, damages, expenses or liabilities whatsoever, arising out of the failure of such Unit Owner to pay the tourist development tax and/or any other tax or surcharge imposed by the State of Florida with respect to rental payments or other charges under the lease, and such Unit Owner shall be solely responsible for and shall pay to the applicable taxing authority, prior to delinquency, the tourist development tax and/or any other tax or surcharge due with respect to rental payments or other charges under the lease.

- 17.9 Weight, Sound and other Restrictions. Unless installed in the Unit prior to the recordation of this Declaration or meeting the sound insulation specifications established from time to time by the Board, hard and/or heavy surface floor coverings, such as tile, marble, wood, and the like will not be permitted in Units. Even once approved by the Board, the installation of insulation materials shall be performed in a manner that provides proper mechanical isolation of the flooring materials from any rigid part of the building structure, whether of the concrete subfloor (vertical transmission) or adjacent walls and fittings (horizontal transmission) and same must be installed prior to the Unit being occupied. Chipping, grinding and/or bushing of the concrete slab is expressly prohibited. Additionally, the floor coverings (and insulation and adhesive material therefor) installed subsequent to the recordation of this Declaration on any porch shall not exceed a thickness that will result in the finish level of the porch being above the bottom of the scuppers or diminish the required height of the rails (as established by the

applicable building code). Also, the installation of any improvement or heavy object must be submitted to and approved by the Board, and be compatible with the overall structural design of the Building. All areas within a Unit, unless containing floor coverings installed prior to the recordation of this Declaration or to receive floor covering approved by the Board, are to receive sound absorbent, less dense floor coverings, such as carpeting. The Board will have the right to specify the exact material to be used on porches. Any use guidelines set forth by the Association shall be consistent with good design practices for the waterproofing and overall structural design of the Building. Owners will be held strictly liable for violations of these restrictions and for all damages resulting therefrom and the Association has the right to require immediate removal of violations. **Applicable warranties of the Developer, if any, shall be voided by violations of these restrictions and requirements. Each Owner, by acceptance of a deed or other conveyance of their Unit, hereby acknowledges and agrees that sound transmission in a Condominium is very difficult to control, and that noises from adjoining or nearby Units and or mechanical equipment can often be heard in another Unit. The Developer does not make any representation or warranty as to the level of sound transmission between and among Units and the other portions of the Condominium Property, and each Owner shall be deemed to waive and expressly release any such warranty and claim for loss or damages resulting from sound transmission.**

- 17.10 Mitigation of Dampness and Humidity. No Unit Owner shall install, within his or her Unit, or upon the Common Elements or Association Property, non-breathable wall-coverings or low-permeance paints. Additionally, any and all built-in casework, furniture, and or shelving in a Unit must be installed over floor coverings to allow air space and air movement and shall not be installed with backboards flush against any gypsum board, masonry block or concrete wall. Additionally, all Unit Owners, whether or not occupying the Unit, shall periodically run the air conditioning system to maintain the Unit temperature, whether or not occupied, at 78°F, to minimize humidity in the Unit. Leaks, leaving exterior doors or windows open, wet flooring and moisture will contribute to the growth of mold, mildew, fungus or spores. Each Unit Owner, by acceptance of a deed, or otherwise acquiring title to a Unit, shall be deemed to have agreed that Developer is not responsible, and hereby disclaims any responsibility for any illness, personal injury, death or allergic reactions which may be experienced by the Unit Owner, its family members and/or its or their guests, tenants and invitees and/or the pets of all of the aforementioned persons, as a result of mold, mildew, fungus or spores. It is the Unit Owner's responsibility to keep the Unit clean, dry, well-ventilated and free of contamination. While the foregoing are intended to minimize the potential development of molds, fungi, mildew and other mycotoxins, each Unit Owner understands and agrees that there is no method for completely eliminating the development of molds or mycotoxins. The Developer does not make any representations or warranties regarding the existence or development of molds or mycotoxins and each Unit Owner shall be deemed to waive and expressly release any such warranty and claim for loss or damages resulting from the existence and/or development of same. In furtherance of the rights of the Association as set forth in Section 11.1(a) above, in the event that the Association reasonably believes that the provisions of this Section 17.10 are not being complied with, then, the Association shall have the right (but not the obligation) to enter the Unit (without requiring the consent of the Unit Owner or any other party) to turn on the air conditioning in an effort to cause the temperature of the Unit to be maintained as required hereby (with all utility consumption costs to be paid and assumed by the Unit Owner). To the extent that electric service is not then available to the Unit, the Association shall have the further right, but not the obligation (without requiring the consent of the Unit Owner or any other party) to connect electric service to the Unit (with the costs thereof to be borne by the Unit Owner, or if advanced by the Association, to be promptly reimbursed by the Unit Owner to the Association, with all such costs to be deemed Charges hereunder). Each Unit Owner, by acceptance of a deed or other conveyance of a Unit, holds Developer harmless and agrees to indemnify the Developer from and against any and all claims made by the Unit Owner and the Unit Owner's guests, tenants and

invitees on account of any illness, allergic reactions, personal injury and death to such persons and to any pets of such persons, including all expenses and costs associated with such claims including, without limitation, inconvenience, relocation and moving expenses, lost time, lost earning power, hotel and other accommodation expenses for room and board, all attorneys fees and other legal and associated expenses through and including all appellate proceedings with respect to all matters mentioned in this Subsection 17.10.

- 17.11 Exterior Improvements. Without limiting the generality of Subsections 9.1 or 17.4 hereof, but subject to any provision of this Declaration specifically permitting same, no Unit Owner shall cause anything to be affixed or attached to, hung, displayed or placed on the exterior walls, doors, porches or windows of the Building (including, but not limited to, awnings, signs, storm shutters, satellite dishes, screens, window tinting, furniture, fixtures and equipment), without the prior written consent of the Association. Notwithstanding the foregoing, any Unit Owner may display one portable removable United States flag in a respectful way, and, on Armed Forces Day, Memorial Day, Flag Day, Independence Day and Veterans Day, may display in a respectful way portable, removable official flags, not larger than 4<sup>1</sup>/<sub>2</sub> feet by 6 feet, that represent the United States Army, Navy, Air Force, Marine Corps or Coast Guard.
- 17.12 Association Access to Units. In order to facilitate access to Units by the Association for the purposes enumerated in Subsection 11.1(a) hereof, it shall be the responsibility of all Unit Owners to deliver a set of keys to their respective Units (or to otherwise make access available) to the Association for use in the performance of its functions. No Unit Owner shall change the locks to his or her Unit (or otherwise preclude access to the Association) without so notifying the Association and delivering to the Association a new set of keys (or otherwise affording access) to such Unit.
- 17.13 Exterior Storm Shutters. The Board of Directors shall, from time to time, establish exterior storm shutter specifications which comply with the applicable building code, and establish permitted colors, styles and materials for exterior storm shutters. Subject to the provisions of Subsection 9.1 above, the Association shall approve the installation or replacement of exterior storm shutters conforming with the Board's specifications. The Board may, with the approval of a majority of the voting interests in the Condominium, install exterior storm shutters, and may (without requiring approval of the membership) maintain, repair or replace such approved shutters, whether on or within Common Elements, Limited Common Elements, Units or Association Property; provided, however, that if laminated glass, in accordance with all applicable building codes and standards, architecturally designed to serve as hurricane protection, is installed, the Board may not install exterior storm shutters in accordance with this provision. All shutters shall remain open and no shutters shall be placed upon windows unless and until a storm watch or storm warning is announced by the National Weather Center or other recognized weather forecaster. A Unit Owner or occupant who plans to be absent during all or any portion of the hurricane season must prepare his or her Unit prior to his or her departure by designating a responsible firm or individual to care for his or her Unit should a hurricane threaten the Unit or should the Unit suffer hurricane damage, and furnishing the Association with the name(s) of such firm or individual.

To the extent that Developer provides exterior storm shutters for any portions of the Buildings (which it is not obligated to do) or if the Association obtains exterior storm shutters for any portion of the Condominium Property, the Association (as to shutters for the Common Elements) and the Unit Owners (as to shutters covering doors or windows to a Unit) shall be solely responsible for the installation of such exterior storm shutters from time to time and the costs incurred by the Association (as to installation of shutters for the Common Elements) shall be deemed a part of the Common Expenses of the Condominium that are included in the Assessments payable by Unit Owners. The obligations of the Association assumed hereby shall include, without limitation, development of appropriate plans to allow for the timely installation of the shutters for

the Common Elements, and all obligations with respect to the repair, replacement and/or upgrade of the shutters for the Common Elements. Developer shall have no obligations with respect to the installation of the shutters, and/or for the repair, replacement and/or upgrade of the shutters. Nothing herein shall obligate the Association to install shutters protecting individual units, nor to put up, take down, open or close same as a storm is approaching, or after it passes.

- 17.14 Recorded Agreements. The use of the Units, the Condominium Property and the Association Property shall at all times comply with all restrictions, covenants, conditions, limitations, agreements, reservations and easements now or hereafter recorded in the public records.
- 17.15 Relief by Association. The Association shall have the power (but not the obligation) to grant relief in particular circumstances from the provisions of specific restrictions contained in this Section 17 for good cause shown, as determined by the Association in its sole discretion.
- 17.16 Effect on Developer. Subject to the following exceptions, the restrictions and limitations set forth in this Section 17 shall not apply to the Developer nor to Units owned by the Developer. The Developer shall not be exempt from the restrictions, if any, relating to requirements that leases or lessees be approved by the Association, pet restrictions, occupancy of Units based on age and vehicular restrictions, except as such vehicular restrictions relate to the Developer's construction, maintenance, sale, resales, leasing and other marketing and financing activities, which activities the Developer can perform without the prior consent of the Unit Owners.
- 17.17 Cumulative with Restrictions of Master Covenants. The foregoing restrictions shall be in addition to, cumulative with, and not in derogation of those set forth in the Master Covenants.
18. Compliance and Default. The Association, each Unit Owner, occupant of a Unit, tenant and other invitee of a Unit Owner shall be governed by and shall comply with the terms of this Declaration and all exhibits annexed hereto, the Master Covenants, and the rules and regulations adopted pursuant to those documents, as the same may be amended from time to time and the provisions of all of such documents shall be deemed incorporated into any lease of a Unit whether or not expressly stated in such lease. The Association (and Unit Owners, if appropriate) shall be entitled to the following relief in addition to the remedies provided by the Act:
- 18.1 Mandatory Nonbinding Arbitration of Disputes. Prior to the institution of court litigation, the parties to a Dispute shall petition the Division for nonbinding arbitration. The arbitration shall be conducted according to rules promulgated by the Division and before arbitrators employed by the Division. The filing of a petition for arbitration shall toll the applicable statute of limitation for the applicable Dispute, until the arbitration proceedings are completed. Any arbitration decision shall be presented to the parties in writing, and shall be deemed final if a complaint for trial de novo is not filed in a court of competent jurisdiction in which the Condominium is located within thirty (30) days following the issuance of the arbitration decision. The prevailing party in the arbitration proceeding shall be awarded the costs of the arbitration, and attorneys' fees and costs incurred in connection with the proceedings. The party who files a complaint for a trial de novo shall be charged the other party's arbitration costs, courts costs and other reasonable costs, including, without limitation, attorneys' fees, investigation expenses and expenses for expert or other testimony or evidence incurred after the arbitration decision, if the judgment upon the trial de novo is not more favorable than the arbitration decision. If the judgment is more favorable, the party who filed a complaint for trial de novo shall be awarded reasonable court costs and attorneys' fees. Any party to an arbitration proceeding may enforce an arbitration award by filing a petition in a court of competent jurisdiction in which the Condominium is located. A petition may not be granted unless the time for appeal by the filing of a complaint for a trial de novo has

expired. If a complaint for a trial de novo has been filed, a petition may not be granted with respect to an arbitration award that has been stayed. If the petition is granted, the petitioner may recover reasonable attorneys' fees and costs incurred in enforcing the arbitration award.

- 18.2 Negligence and Compliance. A Unit Owner and/or tenant of a Unit shall be liable for the expense of any maintenance, repair or replacement made necessary by the Owner's negligence or by that of any member of the Owner's family or the Owner's guests, employees, agents, invitees or lessees, but only to the extent such expense is not met by the proceeds of insurance actually collected in respect of such negligence by the Association. In the event a Unit Owner, tenant or occupant fails to maintain a Unit or fails to cause such Unit to be maintained, or fails to observe and perform all of the provisions of the Declaration, the By-Laws, applicable rules and regulations, or any other agreement, document or instrument affecting the Condominium Property or administered by the Association, in the manner required, the Association shall have the right to proceed in equity to require performance and/or compliance, to impose any applicable fines (in accordance with the provisions of Subsection 18.3 below), to sue at law for damages, and to charge the Unit Owner for the sums necessary to do whatever work is required to put the Unit Owner or Unit in compliance, provided, however, that nothing contained in this Subsection 18.2 shall authorize the Association to enter a Unit to enforce compliance. In any proceeding arising because of an alleged failure of a Unit Owner, a tenant or the Association to comply with the requirements of the Act, this Declaration, the exhibits annexed hereto, or the rules and regulations adopted pursuant to said documents, as the same may be amended from time to time, the prevailing party shall be entitled to recover the costs of the proceeding and such reasonable attorneys' fees (including appellate attorneys' fees). A Unit Owner prevailing in an action with the Association, in addition to recovering his or her reasonable attorneys' fees, may recover additional amounts as determined by the court to be necessary to reimburse the Unit Owner for his or her share of Assessments levied by the Association to fund its expenses of the litigation.
- 18.3 Fines. In addition to any and all other remedies available to the Association, a fine or fines may be imposed upon an Owner for failure of an Owner, his or her family, guests, invitees, lessees or employees, to comply with any covenant, restriction, rule or regulation herein or By-Laws or Rules and Regulations of the Association, provided the following procedures are adhered to:
- (a) Notice: The party against whom the fine is sought to be levied shall be afforded an opportunity for hearing after reasonable notice of not less than fourteen (14) days and said notice shall include: (i) a statement of the date, time and place of the hearing; (ii) a statement of the provisions of the Declaration, By-Laws, or rules which have allegedly been violated; and (iii) a short and plain statement of the matters asserted by the Association.
  - (b) Hearing: The non-compliance shall be presented to a committee of other Unit Owners, who shall hear reasons why penalties should not be imposed. The party against whom the fine may be levied shall have an opportunity to respond, to present evidence, and to provide written and oral argument on all issues involved and shall have an opportunity at the hearing to review, challenge, and respond to any material considered by the committee. A written decision of the committee shall be submitted to the Owner or occupant by not later than twenty-one (21) days after the meeting. If the committee does not agree with the fine, the fine may not be levied.
  - (c) Fines: The Board of Directors may impose fines against the applicable Unit up to the maximum amount permitted by law from time to time. At the time of the recordation of this Declaration, the Act provides that no fine may exceed \$100.00 per violation, or \$1,000.00 in the aggregate.

- (d) Violations: Each separate incident which is grounds for a fine shall be the basis of one separate fine. In the case of continuing violations, each continuation of same after a notice thereof is given shall be deemed a separate incident.
  - (e) Payment of Fines: Fines shall be paid not later than thirty (30) days after notice of the imposition thereof.
  - (f) Application of Fines: All monies received from fines shall be allocated as directed by the Board of Directors.
  - (g) Non-exclusive Remedy: These fines shall not be construed to be exclusive and shall exist in addition to all other rights and remedies to which the Association may be otherwise legally entitled; however, any penalty paid by the offending Owner or occupant shall be deducted from or offset against any damages which the Association may otherwise be entitled to recover by law from such Owner or occupant.
19. Termination of Condominium. The Condominium shall continue until (a) terminated by casualty loss, condemnation or eminent domain, as more particularly provided in this Declaration, or (b) such time as withdrawal of the Condominium Property from the provisions of the Act is authorized by a vote of Owners owning at least 80% of the applicable interests in the Common Elements and by the Institutional First Mortgagees of Units to which at least sixty-seven percent (67%) of the voting interests of Units subject to mortgages held by Institutional First Mortgagees are appurtenant. In the event such withdrawal is authorized as aforesaid, and provided that the Board first notifies the Division of an intended withdrawal, the Condominium Property shall be subject to an action for partition by any Unit Owner, mortgagee or lienor as if owned in common in which event the net proceeds of the partition sale shall be divided among all Unit Owners in proportion to their respective interests in the Common Elements, provided, however, that no payment shall be made to a Unit Owner until there has first been paid off out of the Owner's share of such net proceeds all mortgages and liens on the Owner's Unit in the order of their priority. The termination of the Condominium, as aforesaid, shall be evidenced by a certificate of the Association executed by its President and Secretary, certifying as to the basis of the termination and said certificate shall be recorded among the public records of the County. The Association shall, within thirty (30) business days following such recordation, provide the Division with a copy of such recorded certificate. This Section may not be amended without the consent of the Developer as long as it owns any Unit. The rights under this Section shall exist so long as the Developer holds a Unit for sale in the ordinary course of business.
20. Additional Rights of Mortgagees and Others.
- 20.1 Availability of Association Documents. The Association shall have current and updated copies of the following available for inspection by Institutional First Mortgagees during normal business hours or under other reasonable circumstances as determined by the Board: (a) this Declaration; (b) the Articles; (c) the By-Laws; (d) the rules and regulations of the Association; and (e) the books, records and financial statements of the Association.
  - 20.2 Amendments. Subject to the other provisions of this Declaration and except as provided elsewhere to the contrary, an amendment directly affecting any of the following shall require the approval of a Majority of Institutional First Mortgagees: (a) voting rights; (b) a reallocation of responsibility for Common Expenses or a change in the priority of assessment liens; (c) reductions in reserves for maintenance, repair and replacement of Common Elements and/or Association Property; (d) responsibility for maintenance and repairs; (e) reallocation of interests in the Common Elements (including Limited Common Elements) or rights to their use; (f) redefinition of Unit boundaries; (g) conversion of Units into Common Elements or Common Elements into Units; (h) expansion or contraction of the Condominium; (i) hazard or fidelity insurance requirements; (j) imposition of restrictions on leasing of units; (k) imposition of

restrictions on the selling or transferring of title to Units; (l) restoration or repair of the Condominium after a casualty or partial condemnation; (m) any action to terminate the Condominium after casualty or condemnation; and (n) any provision that expressly benefits mortgage holders, insurers or guarantors as a class. In accordance with Section 718.110(11), Florida Statutes, any consent required of a mortgagee may not be unreasonably withheld.

20.3 Notices. Any holder, insurer or guarantor of a mortgage on a Unit shall have, if first requested in writing from the Association, the right to timely written notice of:

- (a) any condemnation or casualty loss affecting a material portion of the Condominium and/or Association Property or the affected mortgaged Unit;
- (b) a sixty (60) day delinquency in the payment of the Assessments on a mortgaged Unit;
- (c) the occurrence of a lapse, cancellation or material modification of any insurance policy or fidelity bond maintained by the Association; and
- (d) any proposed action which requires the consent of a specified number of mortgage holders.

20.4 Additional Rights. Institutional First Mortgagees shall have the right, upon written request to the Association, to: (a) receive a copy of an audited financial statement of the Association for the immediately preceding fiscal year if such statements were prepared; and (b) receive notices of and attend Association meetings.

21. Covenant Running With the Land. All provisions of this Declaration, the Articles, By-Laws and applicable rules and regulations of the Association, as well as those of the Master Covenants, shall, to the extent applicable and unless otherwise expressly herein or therein provided to the contrary, be perpetual and be construed to be covenants running with the Land and with every part thereof and interest therein, and all of the provisions hereof and thereof shall be binding upon and inure to the benefit of the Developer and subsequent owner(s) of the Land or any part thereof, or interest therein, and their respective heirs, personal representatives, successors and assigns, but the same are not intended to create nor shall they be construed as creating any rights in or for the benefit of the general public. All present and future Unit Owners, tenants and occupants of Units shall be subject to and shall comply with the provisions of this Declaration and the Articles, By-Laws and applicable rules and regulations, as well as those of the Master Covenants, all as they may be amended from time to time. The acceptance of a deed or conveyance, or the entering into of a lease, or the entering into occupancy of any Unit, shall constitute an adoption and ratification of the provisions of this Declaration, and the Articles, By-Laws and applicable rules and regulations of the Association, the Master Covenants, all as they may be amended from time to time, including, but not limited to, a ratification of any appointments of attorneys-in-fact contained herein.

22. The Master Association. The Condominium is part of a development known as Metrowest (the "Community"). The Condominium Property, the Association, each Unit, and each Unit Owner or other occupant of a Unit, is subject to and bound by the terms and conditions of the Master Covenants and all amendments thereto, which are made from time to time. The Master Covenants provides that the Master Association is responsible for the operation, management, maintenance, repair, and replacement of the common property of the Community. The Association is a member of the Master Association. Unit Owners are not members of the Master Association. The Master Covenants contains certain use restrictions, architectural review criteria, drainage rights over the Property and certain easements affecting all property within the Community.

All costs, fees and assessments for which any Unit Owner may be obligated by virtue of the Master Covenants and any exhibits thereto with regard to the Master Association are a Common Expense of the Association. Assessments for the Master Association common expenses



attributable to Units under the jurisdiction of the Association shall be collected by the Association and remitted to the Master Association, even though such assessments are the responsibility of the Unit Owners. The Association shall include in its budget each year an amount sufficient to pay all assessments for "common expenses" (as defined in the Master Covenants) levied by the Master Association against each Unit which is subject to the jurisdiction of the Association. The Association shall have the duty to collect assessments it imposes which includes the assessments levied by the Master Association.

The Master Association has been granted a lien by the Master Covenants against each Unit in the Condominium, and other rights, to secure payment of any assessment or other amounts due with respect to such Unit. If the Association has not collected its assessments from the Owners under its jurisdiction, it shall notify the Master Association of the name and address of such delinquent Owner(s). The Master Association shall be entitled to rely upon the information given by the Association regarding delinquencies, and may impose a lien upon such delinquent Owner's Unit in accordance with this Declaration. However, the Master Association may, in its sole discretion, elect to collect assessments and other charges in accordance with the provisions of the Master Covenants.

Each Unit Owner, and every lessee, invitee, licensee, agent, servant, guest and family member of any Owner shall be bound by the Articles of Incorporation and Bylaws of the Master Association, the terms and conditions of the Master Covenants, and all rules and regulations promulgated by the Master Association.

The Master Association shall receive the same notification of each meeting of the members of the Association or board or committee thereof, required by the Association's Articles of Incorporation, Bylaws or this Declaration, and a representative of the Master Association has the unrestricted right to attend any such meeting. If proper notice is not given to the Master Association, any action taken at such meeting shall be considered null and void to the same effect as if proper notice had not been given to members of the Association.

No amendment or modification to this Declaration, Bylaws or Articles which would prejudice, abridge, or otherwise adversely affect any rights, benefits, privileges or priorities granted to or reserved to the Master Association shall be binding or effective as to the Master Association unless the Master Association shall consent in writing to such amendment or modification.

Except for those instances where the use is limited pursuant to the Master Covenants, the Unit Owners shall be entitled to use all of Common Area of the Community in accordance with and subject to the terms of the Master Covenants.

23. **Disclaimer of Warranties. Notwithstanding that this Condominium is a conversion of previously occupied premises, Developer has elected to warrant the improvements solely to the extent provided in Section 718.618 Florida Statutes. Except only for those warranties provided in Section 718.618, Florida Statutes (and only to the extent applicable and not yet expired), to the maximum extent lawful Developer hereby disclaims any and all and each and every express or implied warranties, whether established by statutory, common, case law or otherwise, as to the design, construction, sound and/or odor transmission, existence and/or development of molds, mildew, toxins or fungi, furnishing and equipping of the Condominium Property, including, without limitation, any implied warranties of habitability, fitness for a particular purpose or merchantability, compliance with plans, all warranties imposed by statute (other than those imposed by Section 718.618, Florida Statutes, and then only to the extent applicable and not yet expired) and all other express and implied warranties of any kind or character. Developer has not given and the Unit Owner has not relied on or bargained for any such warranties. Each Unit Owner recognizes and agrees that the Unit and Condominium are not new construction and were not constructed by Developer. Each Unit Owner, by accepting a deed to a Unit, or other conveyance thereof, shall be deemed to represent and warrant to Developer that in deciding to acquire the Unit, the Unit Owner relied solely on such Unit Owner's independent**

inspection of the Unit and the Condominium Property as well as the conversion inspection report included in the Prospectus. The Unit Owner has not received nor relied on any warranties and/or representations from Developer of any kind, other than as expressly provided herein.

As to any implied warranty which cannot be disclaimed entirely, all secondary, incidental and consequential damages are specifically excluded and disclaimed (claims for such secondary, incidental and consequential damages being clearly unavailable in the case of implied warranties which are disclaimed entirely above).

Given the climate and humid conditions in Florida, molds, mildew, toxins and fungi may exist and/or develop within the Unit and the Condominium Property. Each Owner is hereby advised that certain molds, mildew, toxins and/or fungi may be, or if allowed to remain for a sufficient period may become, toxic and potentially pose a health risk. By acquiring title to a Unit, each Owner shall be deemed to have assumed the risks associated with molds, mildew, toxins and/or fungi and to have released the Developer and Declarant from any and all liability resulting from same, including, without limitation, any liability for incidental or consequential damages (which may result from, without limitation, the inability to possess the Unit, inconvenience, moving costs, hotel costs, storage costs, loss of time, lost wages, lost opportunities and/or personal injury). Without limiting the generality of the foregoing, leaks, leaving exterior doors or windows open, wet flooring and moisture will contribute to the growth of mold, mildew, fungus or spores. Each Unit Owner, by acceptance of a deed, or otherwise acquiring title to a Unit, shall be deemed to have agreed that the Developer is not responsible, and the Developer hereby disclaims any responsibility for any illness or allergic reactions, personal injury or death which may be experienced by the Unit Owner, its family members and/or its or their guests, tenants and invitees and to any pets of the aforementioned persons as a result of mold, mildew, fungus or spores. It is the Unit Owner's responsibility to keep the Unit clean, dry, well-ventilated and free of contamination.

Each Owner understands and agrees that for some time in the future, it, and its guests, tenants and invitees may be disturbed by the noise, commotion and other unpleasant effects of both on-site and nearby construction activity, including, without limitation, on-site renovations to the Condominium Property, and as a result Owner and its guests, tenants and invitees may be impeded in using portions of the Condominium Property by that activity. Demolition or construction of buildings and other structures within the immediate area or within the view lines of any particular Unit or of any part of the Condominium (the "Views") may block, obstruct, shadow or otherwise affect Views, which may currently be visible from the Unit or from the Condominium. Therefore, each Owner, for itself, its successors and assigns, agrees to release Developer, its partners and its and their officers, members, directors and employees and every affiliate and person related or affiliated in any way with any of them ("Developer's Affiliates") from and against any and all losses, claims, demands, damages, costs and expenses of whatever nature or kind, including attorney's fees and costs, including those incurred through all arbitration and appellate proceedings, related to or arising out of any claim against the Developer or Developer's Affiliates related to Views or the disruption, noise, commotion, and other unpleasant effects of nearby development or construction. As a result of the foregoing, there is no guarantee of view, security, privacy, location, design, density or any other matter.

Lastly, each Owner, by acceptance of a deed or other conveyance of a Unit, understands and agrees that there are various methods for calculating the square footage of a Unit. By accepting title to a Unit, the applicable Owner(s) shall be deemed to have conclusively agreed to accept the size and dimensions of the Unit, regardless of any variances in the square footage from that which may have been disclosed at any time prior to closing, whether included as part of Developer's promotional materials or otherwise. Without limiting the generality of this Section 23, Developer does not make any representation or warranty as to the actual size, dimensions (including ceiling heights) or square footage of any Unit, and each Owner shall be deemed to have fully waived and released any such

warranty. Notwithstanding the foregoing, nothing herein shall excuse the Developer from any liability under, or compliance with, the provisions of section 718.506, Florida Statutes.

24. Additional Provisions.

- 24.1 Notices. All notices to the Association required or desired hereunder or under the By-Laws of the Association shall be sent by certified mail (return receipt requested) to the Association in care of its office at the Condominium, or to such other address as the Association may hereafter designate from time to time by notice in writing to all Unit Owners. Except as provided specifically in the Act, all notices to any Unit Owner shall be sent by first class mail to the Condominium address of such Unit Owner, or such other address as may have been designated by him or her from time to time, in writing, to the Association. All notices to mortgagees of Units shall be sent by first class mail to their respective addresses, or such other address as may be designated by them from time to time, in writing to the Association. All notices shall be deemed to have been given when mailed in a postage prepaid sealed wrapper, except notices of a change of address, which shall be deemed to have been given when received, or five (5) business days after proper mailing, whichever shall first occur.
- 24.2 Interpretation. Except where otherwise provided herein, the Board of Directors of the Association shall be responsible for interpreting the provisions hereof and of any of the Exhibits attached hereto. Such interpretation shall be binding upon all parties unless wholly unreasonable. An opinion of legal counsel that any interpretation adopted by the Association is not unreasonable shall conclusively establish the validity of such interpretation.
- 24.3 Mortgagees. Anything herein to the contrary notwithstanding, the Association shall not be responsible to any mortgagee or lienor of any Unit hereunder, and may assume the Unit is free of any such mortgages or liens, unless written notice of the existence of such mortgage or lien is received by the Association.
- 24.4 Exhibits. There is hereby incorporated in this Declaration all materials contained in the Exhibits annexed hereto, except that as to such Exhibits, any conflicting provisions set forth therein as to their amendment, modification, enforcement and other matters shall control over those hereof.
- 24.5 Signature of President and Secretary. Wherever the signature of the President of the Association is required hereunder, the signature of a vice-president may be substituted therefor, and wherever the signature of the Secretary of the Association is required hereunder, the signature of an assistant secretary may be substituted therefor, provided that the same person may not execute any single instrument on behalf of the Association in two separate capacities.
- 24.6 Governing Law. Should any dispute or litigation arise between any of the parties whose rights or duties are affected or determined by this Declaration, the Exhibits annexed hereto or applicable rules and regulations adopted pursuant to such documents, as the same may be amended from time to time, said dispute or litigation shall be governed by the laws of the State of Florida.
- 24.7 Severability. The invalidity in whole or in part of any covenant or restriction, or any section, subsection, sentence, paragraph, clause, phrase or word, or other provision of this Declaration, the Exhibits annexed hereto, or applicable rules and regulations adopted pursuant to such documents, as the same may be amended from time to time, shall not affect the validity of the remaining portions thereof which shall remain in full force and effect.
- 24.8 Waiver. The failure of the Association or any Unit Owner to enforce any covenant, restriction or other provision of the Act, this Declaration, the exhibits annexed hereto, or

the rules and regulations adopted pursuant to said documents, as the same may be amended from time to time, shall not constitute a waiver of their right to do so thereafter.

- 24.9 Ratification. Each Unit Owner, by reason of having acquired ownership (whether by purchase, gift, operation of law or otherwise), and each occupant of a Unit, by reason of his or her occupancy, shall be deemed to have acknowledged and agreed that all of the provisions of this Declaration, and the Articles and By-Laws of the Association, and applicable rules and regulations, are fair and reasonable in all material respects.
- 24.10 Execution of Documents; Attorney-in-Fact. Without limiting the generality of other Sections of this Declaration and without such other Sections limiting the generality hereof, each Owner, by reason of the acceptance of a deed to such Owner's Unit, hereby agrees to execute, at the request of the Developer, all documents or consents which may be required by all governmental agencies to allow the Developer and its affiliates to complete the plan of development of the Condominium as such plan may be hereafter amended, and each such Owner further appoints hereby and thereby the Developer as such Owner's agent and attorney-in-fact to execute, on behalf and in the name of such Owners, any and all of such documents or consents. This power of attorney is irrevocable and coupled with an interest. The provisions of this Section may not be amended without the consent of the Developer.
- 24.11 Gender; Plurality. Wherever the context so permits, the singular shall include the plural, the plural shall include the singular, and the use of any gender shall be deemed to include all or no genders.
- 24.12 Captions. The captions herein and in the Exhibits annexed hereto are inserted only as a matter of convenience and for ease of reference and in no way define or limit the scope of the particular document or any provision thereof.
- 24.13 Liability. Notwithstanding anything contained herein or in the Articles of Incorporation, By-laws, any rules or regulations of the Association or any other document governing or binding the Association (collectively, the "Association Documents"), the Association, except to the extent specifically provided to the contrary herein, shall not be liable or responsible for, or in any manner be a guarantor or insurer of, the health, safety or welfare of any Owner, occupant or user of any portion of the Condominium and/or Association Property including, without limitation, Owners and their guests, invitees, agents, servants, contractors or subcontractors or for any property of any such persons. Without limiting the generality of the foregoing:
- (a) it is the express intent of the Association Documents that the various provisions thereof which are enforceable by the Association and which govern or regulate the uses of the properties have been written, and are to be interpreted and enforced, for the sole purpose of enhancing and maintaining the enjoyment of the properties and the value thereof;
  - (b) the Association is not empowered, and has not been created, to act as an entity which enforces or ensures the compliance with the laws of the United States, State of Florida, County, City and/or any other jurisdiction or the prevention of tortious activities; and
  - (c) the provisions of the Association Documents setting forth the uses of assessments which relate to health, safety and/or welfare shall be interpreted and applied only as limitations on the uses of assessment funds and not as creating a duty of the Association to protect or further the health, safety or welfare of any person(s), even if assessment funds are chosen to be used for any such reason.

Each Owner (by virtue of the Owner's acceptance of title to the a Unit) and each other person having an interest in or lien upon, or making use of, any portion of the properties (by virtue of accepting such interest or lien or making such use) shall be bound by this

provision and shall be deemed to have automatically waived any and all rights, claims, demands and causes of action against the Association arising from or connected with any matter for which the liability of the Association has been disclaimed hereby. Notwithstanding the foregoing, nothing contained herein shall relieve the Association of its duty of ordinary care, as established by the Act, in carrying out the powers and duties set forth herein. As used herein, "Association" shall include within its meaning all of Association's directors, officers, committee and board members, employees, agents, contractors (including management companies), subcontractors, successors nominees and assigns. The provisions hereof shall also inure to the benefit of Developer, which shall be fully protected hereby.

IN WITNESS WHEREOF, the Developer has caused this Declaration to be duly executed and its corporate seal to be hereunto affixed as of the 13<sup>th</sup> day of April, 2006.

Witnessed by:

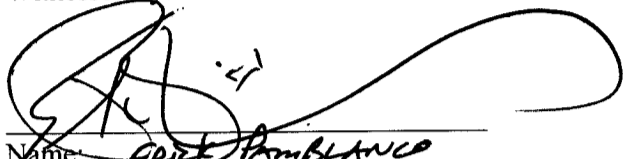
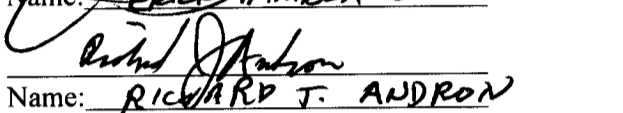
  
Name: Erik Pambanco  
  
Name: RICHARD J. ANDRON

**Birkat Raphael 1, LLC, a Delaware limited liability company**

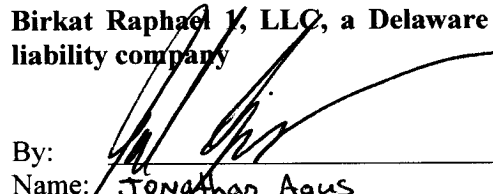
By:   
Name: JONATHAN AGUS  
Title: Authorized Signatory

[CORPORATE SEAL]

Address: 6100 Glades Rd., Suite 305  
Boca Raton, FL 33434

STATE OF FLORIDA )  
COUNTY OF Palm Beach ) SS:

The foregoing Declaration was acknowledged before me, this 13<sup>th</sup> day of April, 2006, by Jonathan Agus, as Authorized Signatory of **Birkat Raphael 1, LLC, a Delaware limited liability company**, on behalf of the limited liability company. He/she is personally known to me or has produced \_\_\_\_\_ as identification.

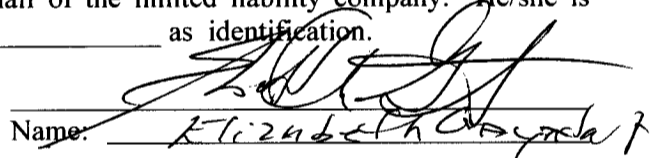
  
Name: Elizabeth Gayadat

Notary Public, State of Florida  
Commission No.: \_\_\_\_\_

My Commission Expires: \_\_\_\_\_

(Notarial Seal)



**JOINDER**

**THE FOUNTAINS AT METRO WEST CONDOMINIUM ASSOCIATION, INC.**, a Florida corporation not for profit, hereby agrees to accept all the benefits and all of the duties, responsibilities, obligations and burdens imposed upon it by the provisions of this Declaration and Exhibits attached hereto.

**IN WITNESS WHEREOF, THE FOUNTAINS AT METRO WEST CONDOMINIUM ASSOCIATION, INC.** has caused these presents to be signed in its name by its proper officer and its corporate seal to be affixed this 13<sup>th</sup> day of April, 2006.

Witnessed by:

**THE FOUNTAINS AT METRO WEST CONDOMINIUM ASSOCIATION, INC.**, a Florida corporation not for profit

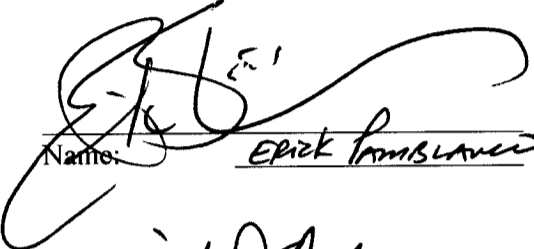
  
Name: ERIK SAMBLANO

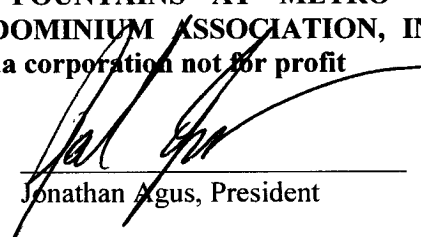
By:   
Jonathan Agus, President

  
Name: RICHARD J. ANDRON

[CORPORATE SEAL]

STATE OF FLORIDA )  
COUNTY OF Palm Beach ) SS:

The foregoing joinder was acknowledged before me this 13<sup>th</sup> day of April, 2006, by Jonathan Agus, as President of **THE FOUNTAINS AT METRO WEST CONDOMINIUM ASSOCIATION, INC.**, a Florida corporation not-for-profit, on behalf of said corporation. He/she is personally known to me or has produced \_\_\_\_\_ as identification.

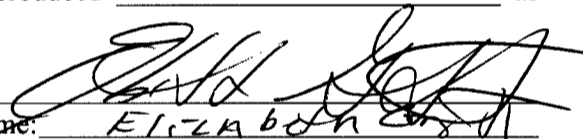
  
Name: ELIZABETH GAYADAT

Notary Public, State of Florida  
Commission No.: \_\_\_\_\_

My Commission Expires:  
\_\_\_\_\_

(Notarial Seal)

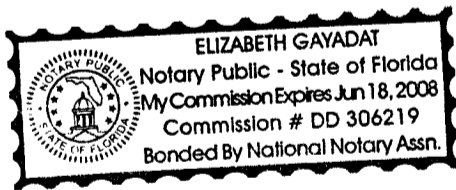

**LIMITED  
JOINDER AND APPROVAL  
DECLARATION OF THE FOUNTAINS AT METRO WEST, A CONDOMINIUM**

The undersigned has executed and delivered this instrument (the "Consent") for the sole purpose of acknowledging its review and approval of the following:

- A. the Declaration of the Fountains at Metro West, a Condominium, to be recorded in the Public Records of Orange County, Florida, with respect to the lands therein described (the "Property");
- B. the Articles of Incorporation for The Fountains At Metro West Condominium Association, Inc. (the "Condominium Association"); and
- C. the By-laws of the Condominium Association

The foregoing documents may be collectively referred to as the "Condominium Governing Documents".



This consent is given by the undersigned, as Developer, as required by the terms and provisions of the Master Declaration of Protective Covenants and Restrictions for MetroWest as recorded in Official Records Book 3759, Page 2756, Public Records of Orange County, Florida, as the same has been amended from time to time (collectively, the "Master Declaration").

This Consent is solely for the purpose of, and limited to, complying with the specific requirements of the Master Declaration as to review and approval of the Condominium Governing Documents. This Consent may not be relied upon by any person or party for any other purpose, including but not limited to, any determination with respect to consistency or compliance with the terms and conditions of the Master Declaration or any other recorded documents, or compliance with any requirements of zoning, land use or other laws, ordinances, rules or regulations of any government entity. If and to the extent that the Property is zoned or designated for use for residential purposes, Developer specifically does not approve changes in use of the Property to any non-residential uses, including but not limited to timeshare, interval ownership, or short-term rental

The execution and delivery of this Consent shall not serve to release or waive any of the terms, conditions or requirements set forth in the Master Declaration or any other recorded documents, all of which shall remain in full force and effect. As provided in the Master Declaration, in Section 1 19, and in the Condominium Governing Documents, in the event of any conflict or inconsistency between the Master Association Governing Documents, and any Community Association Governing Documents, the Master Association Governing Documents shall control and prevail

IN WITNESS WHEREOF, the undersigned has caused these presents to be executed and delivered by its duly authorized officers as of the 22 day of December 2005

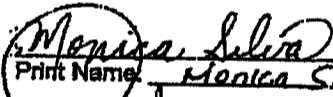
Witness:

  
Print Name: Monica Silva  
  
Print Name: Lynne Mustafa  
(0896)65:1

ALLIANCE LLC, a Florida limited liability company

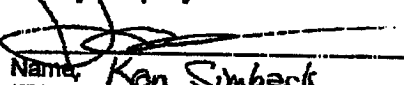
  
Name: Ken Simback  
Title: Manager same number

\*Further, the conversion of the Property to a condominium consisting of the existing units is hereby approved.

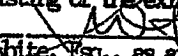
  
Lynne, Esq., as attorney for Alliance, LLC



**CONSENT OF MORTGAGEE**

THIS CONSENT is given as of the 6<sup>th</sup> day of April, 2006, by Corus Bank, NA. ("Mortgagee"), being the owner and holder of that certain Mortgage, Assignment of Rents, Security Agreement and Fixture Filing recorded in Book 08415, Page 3819 of the Public Records of Orange County, Florida (as same may be amended or modified from time to time, and including any and all other documents securing the indebtedness referenced in the Mortgage, Assignment of Rents, Security Agreement and Fixture Filing, the "Mortgage") encumbering the Condominium Property described in the foregoing Declaration.

WHEREAS, Birkat Raphael 1, LLC, a Florida limited liability company ("Developer") has requested Mortgagee to consent to the recording of the Declaration of The Fountains at Metro West, a Condominium (the "Declaration").

NOW, THEREFORE, Mortgagee consents to the recordation of the Declaration.

Mortgagee makes no warranty or any representation of any kind or nature concerning the Declaration, any of its terms or provisions, or the legal sufficiency thereof, and disavows any such warranty or representation as well as any participation in the development of The Fountains at Metro West, a Condominium (the "Condominium"), and does not assume and shall not be responsible for any of the obligations or liabilities of the Developer contained in the Declaration or the prospectus, or other documents issued in connection with the promotion of the Condominium. None of the representations contained in the prospectus or other documents shall be deemed to have been made by Mortgagee, nor shall they be construed to create any obligation on Mortgagee to any person relying thereon. Except only as expressly provided herein, this consent does not affect or impair the rights and remedies of Mortgagee as set forth in the Mortgage or in the Declaration.

Made as of the day and year first above written.

Witnessed by:

Corus Bank, NA.

*Erica Kazimir*  
Name: Erica Kazimir

By: *Brian Brodeur*

Name: Brian Brodeur

Title: Senior Vice President

*Cathy Sucich*  
Name: Cathy Sucich

STATE OF ILLINOIS )  
  ) SS:  
COUNTY OF COOK )

The foregoing instrument was acknowledged before me this 6<sup>th</sup> day of APRIL 2006 by BRIAN J. BRODEUR as SVP of Corus Bank, NA., on behalf of said bank. He/she is personally known to me or has produced \_\_\_\_\_ as identification.

*Rose Odesch*  
Name: \_\_\_\_\_

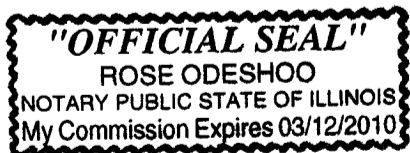

Notary Public, State of \_\_\_\_\_  
My Commission Expires: \_\_\_\_\_  
Commission No.: \_\_\_\_\_

(Notarial Seal)

Exhibit "1" to Declaration of Condominium

Legal Description:

Lot 3, METRO WEST REPLAT, according to the Plat thereof, as recorded in Plat Book 16, pages 115 and 116, Public Records of Orange County, Florida.

**Exhibit "3"**

**THE FOUNTAINS AT METRO WEST, A CONDOMINIUM**

**Schedule of Percentage Shares of Ownership of Common  
Elements and Common Surplus and of Sharing of  
Common Expenses**

<b><u>Unit Type</u></b>	<b><u>% Share</u></b>
A	0.254879819325698%
A1	0.254879819325698%
B	0.287949669301500%
C	0.434747539925795%
D	0.542829488627198%
E	0.528311017906114%
E1	0.507743184384578%

**SURVEYOR'S NOTES**

- THE BEARINGS SHOWN HEREON ARE BASED ON THE NORTH-SOUTH LINE OF METROWEST REPLAT, PLAT BOOK 16, PAGES 107-110, HAVING AN BEARING OF N85°45'31"E.
- NO UNDERGROUND IMPROVEMENTS HAVE BEEN LOCATED EXCEPT AS SHOWN.
- I HAVE EXAMINED THE FLOOD INSURANCE RATE MAP, COMMUNITY PANEL NUMBER 12095C 0240 E DATED 1/20/00 AND FOUND THE SUBJECT PROPERTY LIES IN ZONE X, AN AREA OUTSIDE THE 500-YEAR FLOOD PLAIN.
- NOT VALID WITHOUT THE SIGNATURE AND ORIGINAL RAISED SEAL OF A FLORIDA LICENSED PROFESSIONAL SURVEYOR & MAPPER.
- ALL RECORDING INFORMATION SHOWN HEREON REFERS TO THE PUBLIC RECORDS OF ORANGE COUNTY.
- THE SUBJECT PROPERTY HAS VEHICULAR ACCESS TO WESTGATE DRIVE, A PUBLIC RIGHT OF WAY.
- ALL IMPROVEMENTS ARE EXISTING.
- DIMENSIONS AND ELEVATIONS AS SHOWN HEREON ARE APPROXIMATE.
- INTERIOR DIVIDING WALL WIDTHS VARY.
- EXTERIOR WALL WIDTHS VARY.
- SUBJECT TO ALL EASEMENTS SET FORTH IN THE DECLARATION OF CONDOMINIUM AND ALL OTHER MATTERS OF RECORD.
- ELEVATIONS SHOWN HEREON REFER TO M.S.L. DATUM (1929 NAD83) AND ARE EXPRESSED IN FEET AND INCHES TO THE NEAREST 1/16". THE ELEVATION OF THE FINISHED FLOOR OF THE COMMON AREA LOCATED IN SECTION 36, TOWNSHIP 22 RANGE 28 EAST BEING A "X" CUT ON THE SOUTHERLY CURB ENTRANCE TO KIRKMAN COMMERCE CENTER ALONG EAST SIDE OF KIRKMAN ROAD. ELEVATION = 11.304.
- THE DIMENSIONS SET FORTH IN THE DECLARATION OF CONDOMINIUM ARE INCORPORATED HEREIN.
- ALL PORTIONS OF THE CONDOMINIUM PROPERTY NOT INCLUDED WITHIN THE LIMITS OF THE UNITS ARE COMMON ELEMENTS, UNLESS OTHERWISE SHOWN.
- AREAS WITHIN THE UNIT CONTAINING CONCRETE, MENS, DUCTS, PLUMBING, BEARING WALLS, STRUCTURAL SUPPORTS AND OTHER SUCH ITEMS SERVING A UNIT OR UNITS, OR LIMITED COMMON ELEMENTS OF COMMON ELEMENTS HAVE BEEN OMITTED FROM THESE DRAWINGS FOR PURPOSES OF CLARITY.
- EACH EXTERIOR AIR CONDITIONING UNIT SERVING AN INDIVIDUAL UNIT IS A LIMITED COMMON ELEMENT OF THAT UNIT.

- The surveyor has reviewed Chicago Title Insurance Company Title Commitment no. 300500850, dated January 12, 2005.
- Conditions and easements set forth on the Plat of Metro West Replat, according to the plat thereof as recorded in Plat Book 16, Pages 115 and 116, (Applies and Affects-nothing to plat).
- Development Agreement recorded March 4, 1983, in Official Records Book 3354, Page 1337. (Applies and affects: Blanket in nature).
- Terms, covenants, conditions, restrictions, easements, assessments and possible liens created by and recorded in the Declaration of Condominium and the Declaration of Assurances, Agreements, Assurances, and Reservations recorded September 17, 1996, in Official Records Book 3050, Page 4314, as amended by Amendment 1 recorded August 30, 1998, in Official Records Book 514, Page 1077; with Assignment and Assumption of recorded December 8, 2001, in Official Records Book 813, Page 4273; and Second Amendment recorded February 8, 2001, in Official Records Book 8189, Page 2478, of the Public Records of Orange County, Florida, including, but not limited to one or more of the following provisions for private changes or future purchaser or occupant, but limiting any covenant or restriction based on race, color, religion, sex, handicap, familial status or national origin unless and only to the extent that said covenant(s) (c) is exempt under Chapter 42, Section 3007 of the United States Code, or (c) related to handicaps, but does not discriminate against handicapped persons. (Applies and affects: Blanket in nature).
- Development Order recorded in the Public Records of Orange County, Florida, Book 3354, Page 1337, as amended by DBI Development Order Amendment 1 recorded June 12, 1988, in Official Records Book 3797, Page 2309; DBI Development Order Amendment 2 recorded August 12, 1988, in Official Records Book 3797, Page 2309; DBI Development Order Amendment 3 recorded August 12, 1988, in Official Records Book 3797, Page 2309; and DBI Development Order Amendment 4 recorded August 12, 1988, in Official Records Book 3797, Page 2309. (Applies and affects: Blanket in nature).
- Estimate to the Public Records of Orange County, Florida, recorded August 20, 1999, in O.R. Book 5822, Page 690 and in O.R. Book 5822, Page 687. (Applies and affects: Blanket in nature).
- Underground Easement to the City of Orlando and Orange Utilities Commission recorded August 9, 1999, in O.R. Book 5837, Page 2847. (Applies and affects: Blanket in nature).
- Notice of Easement to Time Warner Entertainment-Audience/Newsline Partnership, through its Florida Partnership, recorded August 9, 1999, in O.R. Book 5837, Page 2847. (Applies and affects: Blanket in nature).
- Restrictions and conditions set forth in Social Memory Dead from Babes, Inc. vs. Cross Point Partners at MetroWest, LLC, recorded in Official Records Book 5675, Page 1088. (Applies and affects: Blanket in nature).

Items 1-6 and 11-13 are not survey related and/or not plottable.

**CERTIFICATION:**

THE UNDERSIGNED SURVEYOR BEING DULY AUTHORIZED TO PRACTICE IN THE STATE OF FLORIDA STATES THAT THIS PROPOSED CONDOMINIUM PLAT OF THE FOUNTAINS AT METRO WEST, A CONDOMINIUM CONSISTING OF SHEETS 1 THROUGH 33 OF THIS PLAT, IS ACCORDING TO THE PUBLIC RECORDS OF ORANGE COUNTY, FLORIDA. THE SURVEYOR WITH ARE IN SUFFICIENT DETAIL TO IDENTIFY THE COMMON ELEMENTS AND EACH UNIT AND THEIR LOCATIONS AND APPROXIMATE DIMENSIONS. THIS CONDOMINIUM PLAT IS IN ACCORDANCE WITH THE REQUIREMENTS OF FLORIDA ADMINISTRATIVE CODE RULE 61G17-6, PURSUANT TO CHAPTER 472.027 AND THE FLORIDA STATUTES CHAPTER 718.104(9)(c). THE CONSTRUCTION OF THIS CONDOMINIUM IS SUBSTANTIALLY COMPLETE.

DATE: 1/17/16  
 REG. NO. 3952  
 LICENSED SURVEYOR  
 JOHN B. WEBB

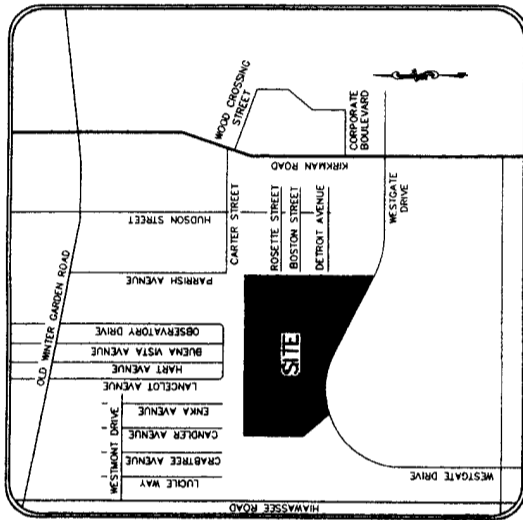

VICINITY MAP  
 NOT TO SCALE

**DESCRIPTION**

LOT 3, METRO WEST REPLAT, according to the Plat thereof, as recorded in Plat Book 16, pages 115 and 116, Public Records of Orange County, Florida.

LAND SURVEYING DIVISION OF  
**John B. Webb & Associates, Inc.**  
 CIVIL & ENVIRONMENTAL CONSULTING ENGINEERS  
 9225 S. DENNING DRIVE  
 WINTER PARK, FLORIDA 32789  
 PH: (407) 622-9322 FAX: (407) 622-9325  
 EMAIL: WEBBENG@AOL.COM

TYPICAL BUILDING DETAIL  
 NOT TO SCALE

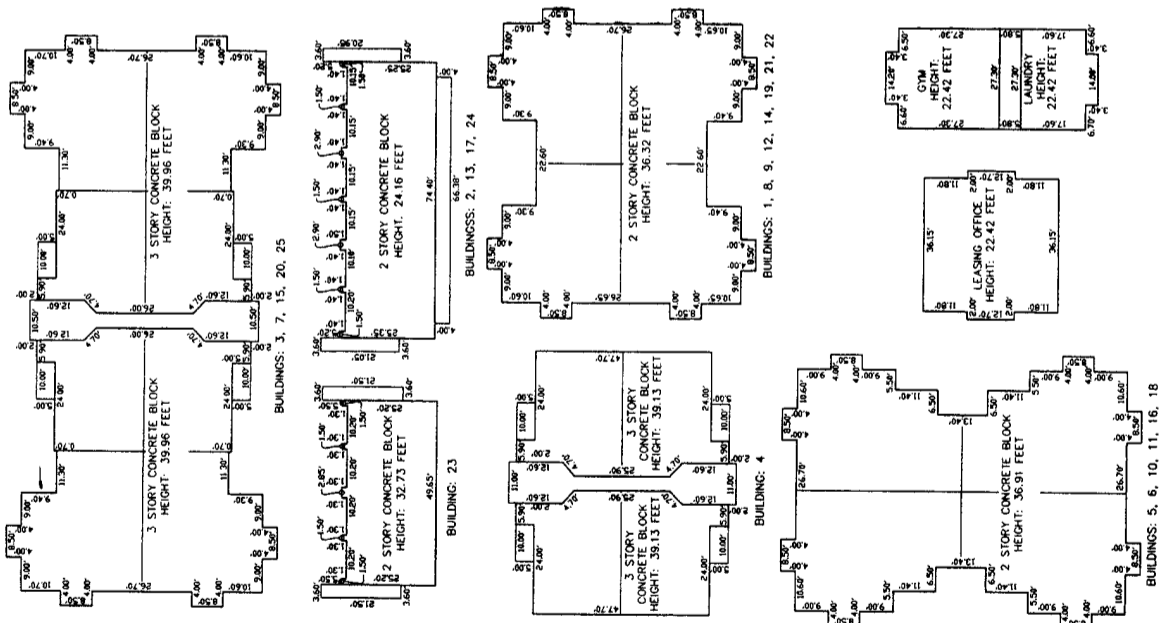



# THE FOUNTAINS AT METRO WEST, A CONDOMINIUM

A CONDOMINIUM LYING IN SECTION 36, TOWNSHIP 22 SOUTH, RANGE 28 EAST, ORANGE COUNTY, FLORIDA

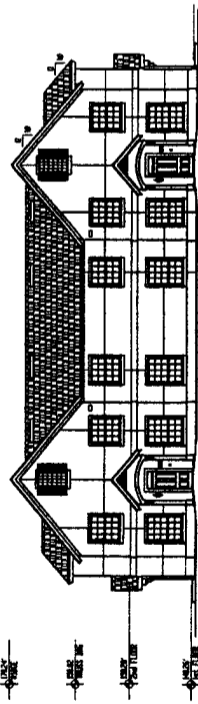

BUILDING 1 - FRONT ELEVATION

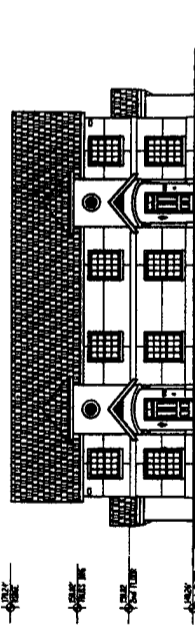

BUILDING 1 - SIDE ELEVATION

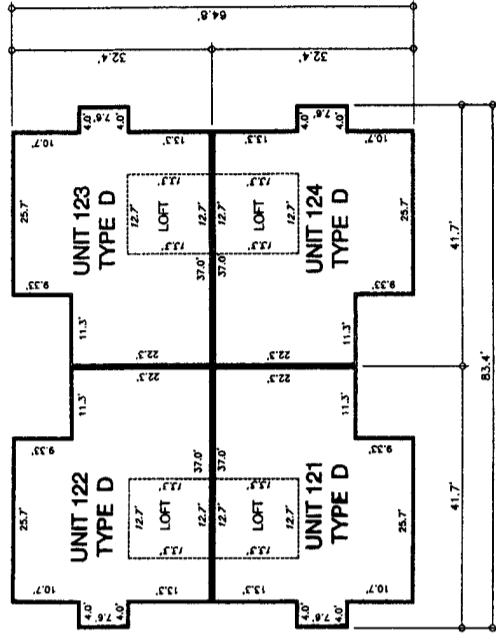

2ND FLOOR

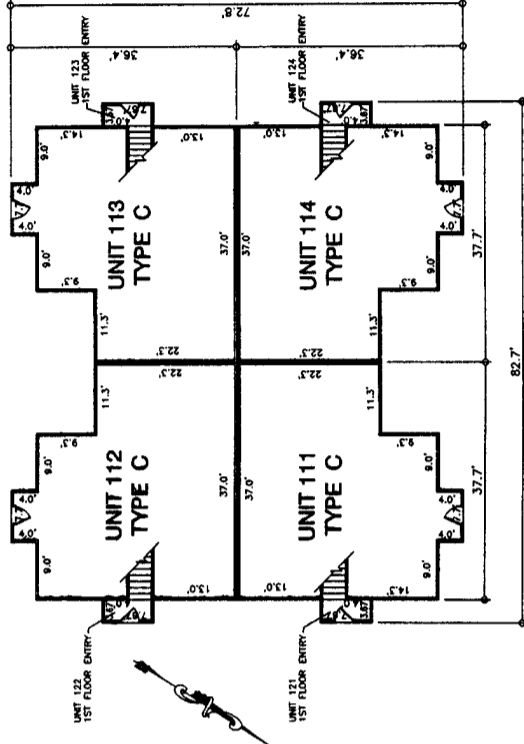

1ST FLOOR

LEGEND:  
 CC COMMON ELEMENT  
 LC LIMITED COMMON ELEMENT  
 STOR. STORAGE

NOTES:  
 ALL DIMENSIONS ARE APPROXIMATED.  
 ALL STORAGE AND FINISHES ARE LIMITED COMMON ELEMENTS.  
 EACH GARAGE IS A COMMON ELEMENT UNIT ASSIGNED TO A PARTICULAR UNIT. AT WHICH TIME, THE GARAGE BECOMES A LIMITED COMMON ELEMENT OF THE UNIT TO WHICH IT IS ASSIGNED.  
 ALL IMPROVEMENTS OUTSIDE OF THE UNITS AND NOT LABELED LIMITED COMMON ELEMENTS ARE COMMON ELEMENTS.

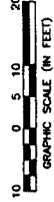

LAND SURVEYING DIVISION OF  
**Solar B. Webb & Associates, Inc.**  
 CIVIL & ENVIRONMENTAL ENGINEERS  
 805 S. US HWY 1  
 WINTER PARK, FLORIDA 32789  
 PH: (407) 822-8322 FAX: (407) 822-8325  
 EMAIL: WEBBENR@AOL.COM

# THE FOUNTAINS AT METRO WEST, A CONDOMINIUM

A CONDOMINIUM LYING IN SECTION 36, TOWNSHIP 22 SOUTH, RANGE 28 EAST, ORANGE COUNTY, FLORIDA

CONDOMINIUM BOOK PAGE

EXHIBIT 2\* TO DECLARATION OF CONDOMINIUM

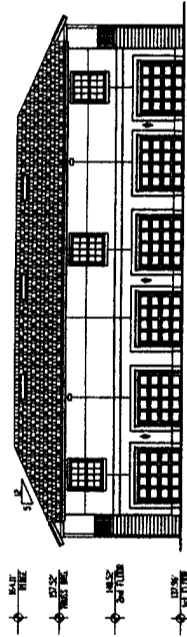

BUILDING 2 - FRONT ELEVATION

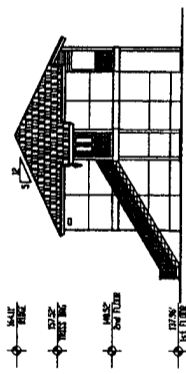

BUILDING 2 - SIDE ELEVATION

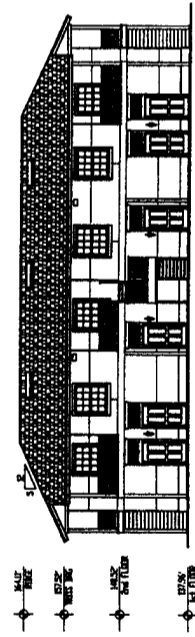

BUILDING 2 - REAR ELEVATION

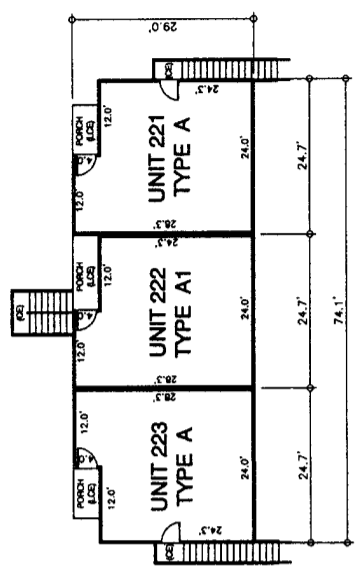

2ND FLOOR

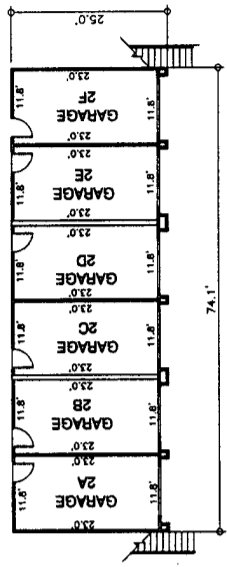

1ST FLOOR

LEGEND:  
 CE COMMON ELEMENT  
 LCE LIMITED COMMON ELEMENT  
 STOR. STORAGE

NOTES:  
 ALL DIMENSIONS ARE APPROXIMATED.  
 ALL STORAGE AND PORCHES ARE LIMITED COMMON ELEMENTS.  
 EACH GARAGE IS A COMMON ELEMENT UNLESS ASSIGNED TO A PARTICULAR UNIT. GARAGES ARE LIMITED COMMON ELEMENTS TO WHICH IT IS ASSIGNED.  
 ALL IMPROVEMENTS OUTSIDE OF THE UNITS AND NOT LABELED LIMITED COMMON ELEMENTS ARE COMMON ELEMENTS.

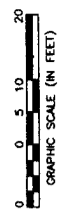

BUILDING 2  
 FLOOR PLANS & ELEVATIONS  
 SHEET 4 OF 33

LAND SURVEYING DIVISION OF  
**Solan R. Webb & Associates, Inc.**  
 CIVIL & ENVIRONMENTAL CONSULTING ENGINEERS  
 925 S. DENNING DRIVE  
 WINTER PARK, FLORIDA 32789  
 PH: (407) 622-8322 FAX: (407) 622-9325  
 EMAIL: WEBBENG@OL.COM

# THE FOUNTAINS AT METRO WEST, A CONDOMINIUM

A CONDOMINIUM LYING IN SECTION 36, TOWNSHIP 22 SOUTH, RANGE 28 EAST, ORANGE COUNTY, FLORIDA

EXHIBIT 2' TO DECLARATION OF CONDOMINIUM

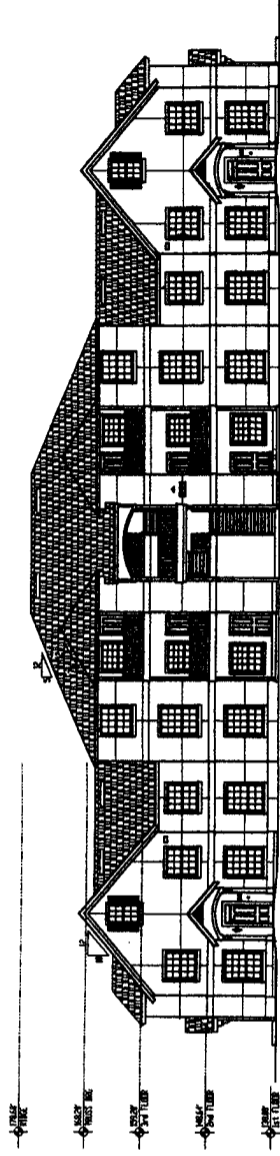

BUILDING 3 - FRONT ELEVATION

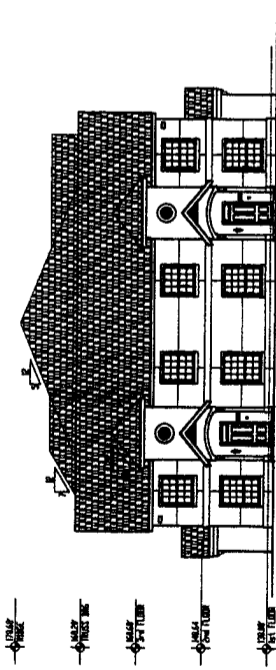

BUILDING 3 - SIDE ELEVATION

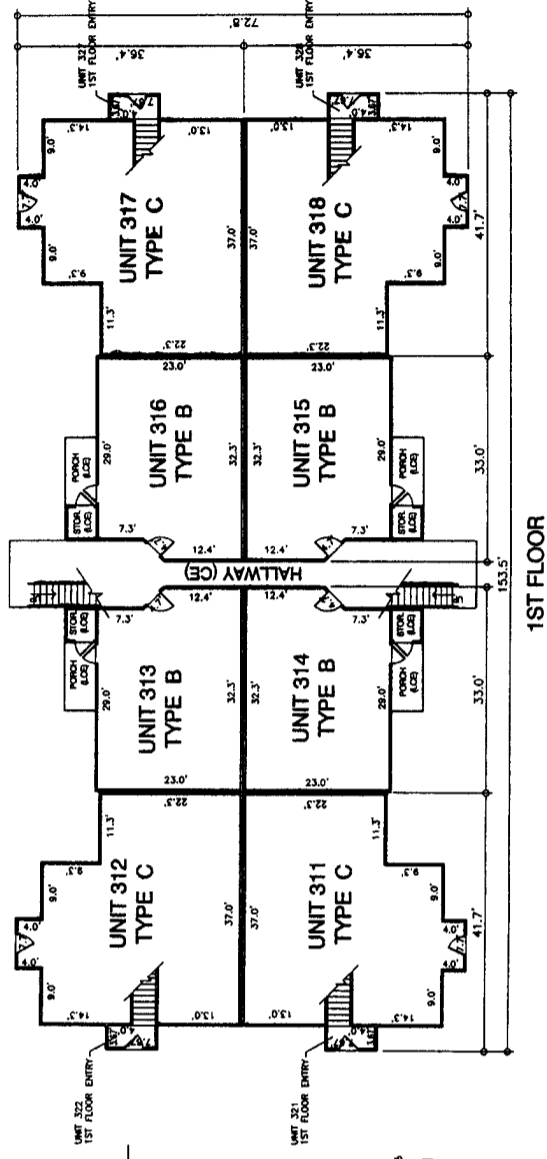

1ST FLOOR

**LEGEND:**  
 CE COMMON ELEMENT  
 LCE LIMITED COMMON ELEMENT  
 S STORAGE  
**NOTES:**  
 ALL DIMENSIONS ARE APPROXIMATED.  
 ALL STORAGE AND PORCHES ARE LIMITED COMMON ELEMENTS.  
 EACH GARAGE IS A COMMON ELEMENT. THE GARAGE BECOMES A LIMITED COMMON ELEMENT OF THE UNIT TO WHICH IT IS ASSIGNED.  
 UNITS AND NOT LABELED LIMITED COMMON ELEMENTS AS THE COMMON ELEMENTS ARE COMMON ELEMENTS.

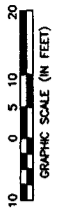

**BUILDING 3**  
 FLOOR PLANS & ELEVATIONS  
 SHEET 5 OF 33

LAND SURVEYING DIVISION OF  
**John R. Webb & Associates, Inc.**  
 CIVIL & ENVIRONMENTAL CONSULTING ENGINEERS  
 825 S. DENNING DRIVE  
 WINTER PARK, FLORIDA 32789  
 PH: (407) 822-9322 FAX: (407) 822-4305  
 EMAIL: WEBBENG@AOL.COM



# THE FOUNTAINS AT METRO WEST, A CONDOMINIUM

A CONDOMINIUM LYING IN SECTION 36, TOWNSHIP 22 SOUTH, RANGE 28 EAST, ORANGE COUNTY, FLORIDA

CONDOMINIUM BOOK PAGE

EXHIBIT 2\* TO DECLARATION OF CONDOMINIUM

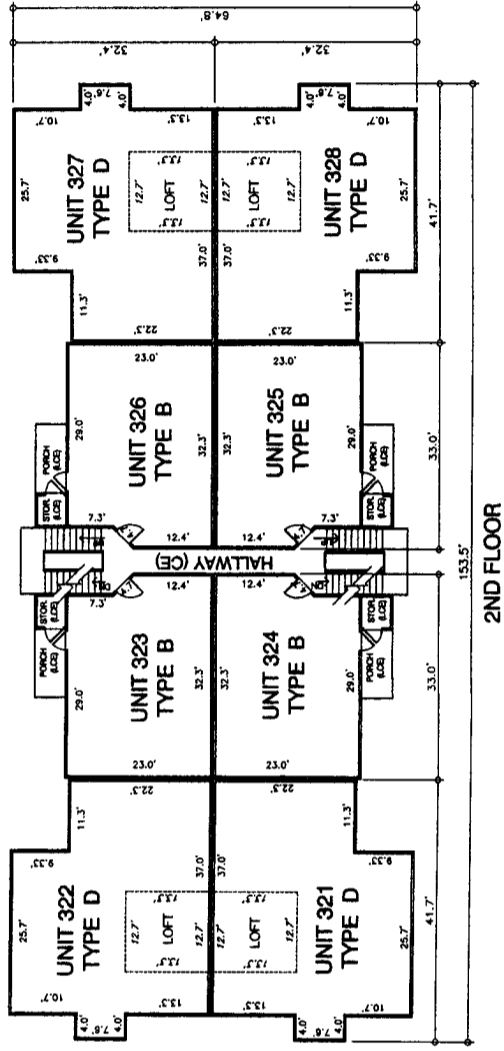
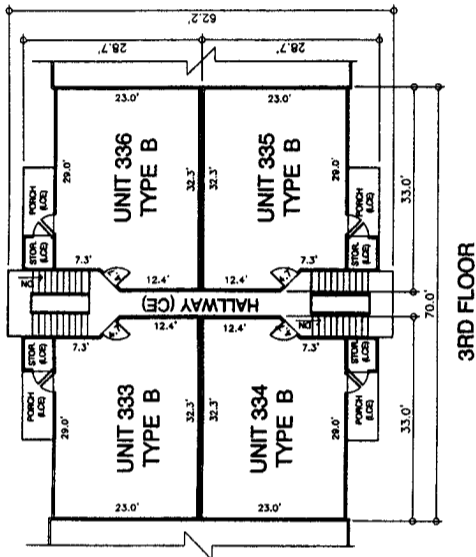

LEGEND:  
 CE COMMON ELEMENT  
 CS COMMON ELEMENT  
 ST STORAGE

NOTES:  
 ALL DIMENSIONS ARE APPROXIMATED.  
 ALL STORAGE AND PORCHES ARE LIMITED COMMON ELEMENTS.  
 EACH GARAGE IS A COMMON ELEMENT ASSIGNED TO A PARTICULAR UNIT. IMPROVEMENTS OUTSIDE OF THE UNIT ARE LIMITED COMMON ELEMENTS OF THE UNIT TO WHICH IT IS ASSIGNED.  
 ALL IMPROVEMENTS OUTSIDE OF THE UNIT ARE LIMITED COMMON ELEMENTS OF THE UNIT TO WHICH IT IS ASSIGNED.

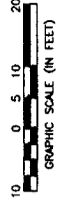

**BUILDING 3**  
**FLOOR PLANS**  
 SHEET 6 OF 33

LAND SURVEYING BRANCH OF  
**John R. Webb & Associates, Inc.**  
 CIVIL & ENVIRONMENTAL CONSULTING ENGINEERS  
 380 S. BOYD AVE.  
 TAMPA, FLORIDA 33609  
 PHONE: (813) 281-1111 FAX: (813) 281-1125  
 EMAIL: WEBB@WEBB-INC.COM

**THE FOUNTAINS AT METRO WEST, A CONDOMINIUM**

A CONDOMINIUM LYING IN SECTION 36, TOWNSHIP 22 SOUTH, RANGE 28 EAST, ORANGE COUNTY, FLORIDA

CONDOMINIUM BOOK PAGE

EXHIBIT 2' TO DECLARATION OF CONDOMINIUM

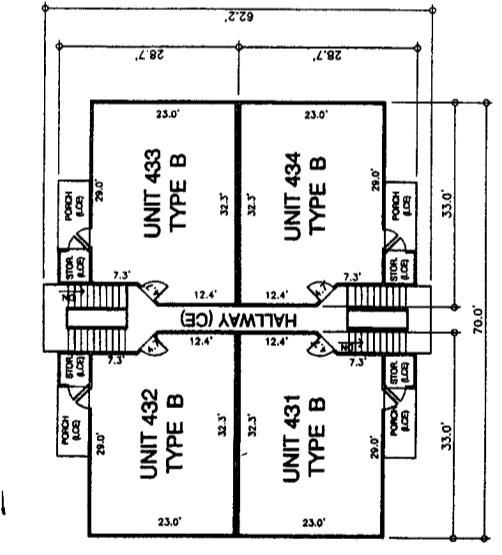

3RD FLOOR

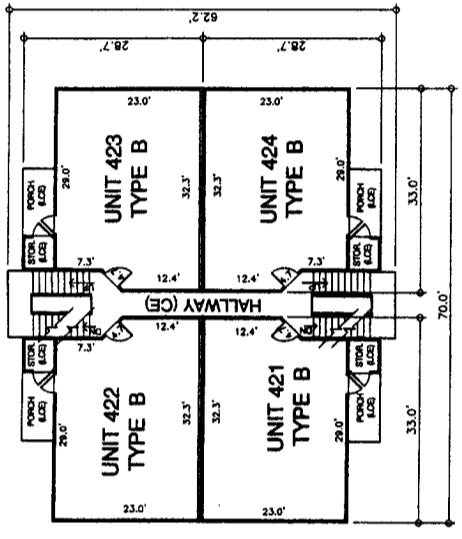

2ND FLOOR

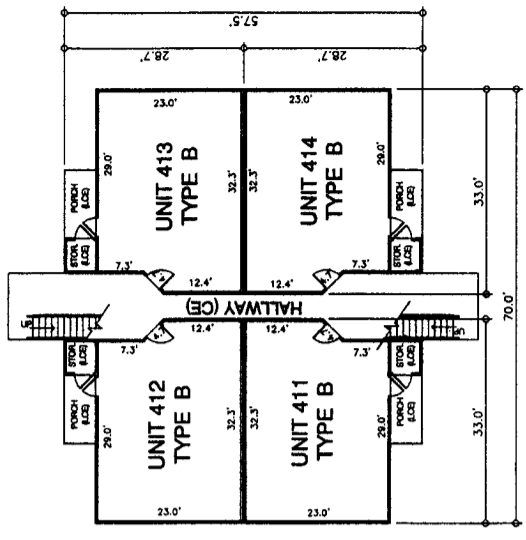

1ST FLOOR



BUILDING 4 - FRONT ELEVATION



BUILDING 4 - SIDE ELEVATION

**LEGEND:**  
 CE COMMON ELEMENT  
 STOR COMMON ELEMENT STORAGE

**NOTES:**  
 ALL DIMENSIONS ARE APPROXIMATED.  
 ALL STORAGE AND PORCHES ARE LIMITED COMMON ELEMENTS.  
 EACH GARAGE IS A COMMON ELEMENT UNLESS ASSIGNED TO A PARTICULAR UNIT.  
 UNITS ASSIGNED TO A PARTICULAR UNIT ARE LIMITED COMMON ELEMENTS OF THE UNIT TO WHICH IT IS ASSIGNED.  
 ALL IMPROVEMENTS OUTSIDE OF THE UNIT ARE LIMITED COMMON ELEMENTS UNLESS OTHERWISE SPECIFIED.  
 COMMON ELEMENTS ARE COMMON ELEMENTS.



**BUILDING 4**  
**FLOOR PLANS & ELEVATIONS**  
 SHEET 7 OF 33

LAND SURVEYING DIVISION OF  
**John R. Webb & Associates, Inc.**  
 CIVIL & ENVIRONMENTAL CONSULTING ENGINEERS  
 825 S. DORNING DRIVE  
 WINTER PARK, FLORIDA 32789  
 PH: (407) 942-1100 FAX: (407) 922-9325  
 EMAIL: WEBBER@JRA.UM.COM

# THE FOUNTAINS AT METRO WEST, A CONDOMINIUM

A CONDOMINIUM LYING IN SECTION 36, TOWNSHIP 22 SOUTH, RANGE 28 EAST, ORANGE COUNTY, FLORIDA

CONDOMINIUM BOOK PAGE

EXHIBIT 2 TO DECLARATION OF CONDOMINIUM

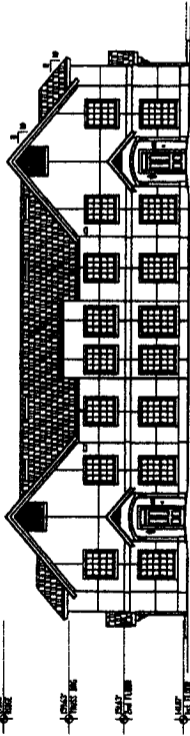

BUILDING 5 - FRONT ELEVATION

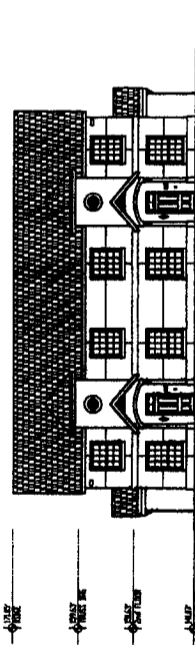

BUILDING 5 - SIDE ELEVATION

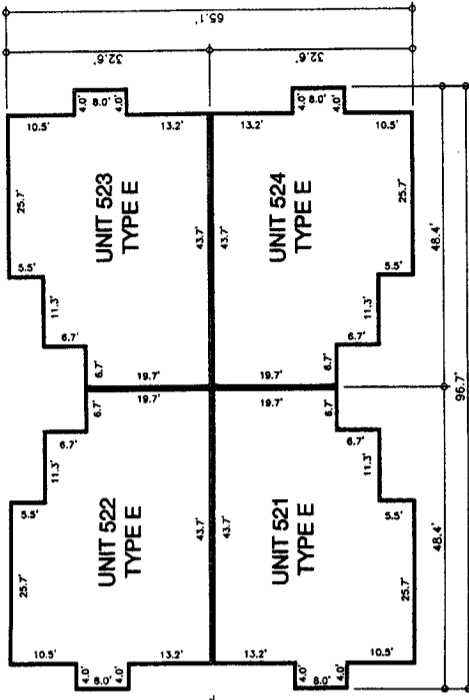

2ND FLOOR

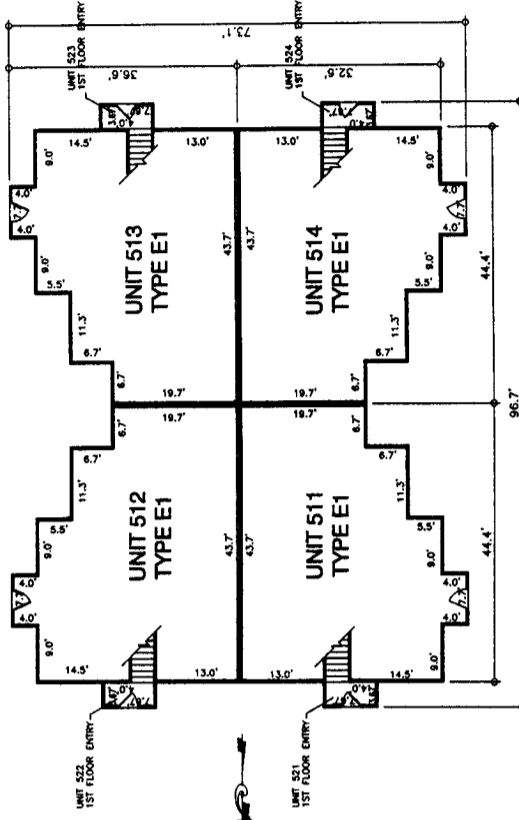

1ST FLOOR

LEGEND:  
 CC COMMON ELEMENT  
 CC COMMON ELEMENT  
 STOR. STORAGE

NOTES:  
 ALL DIMENSIONS ARE APPROXIMATED.  
 ALL STORAGE AND PORCHES ARE LIMITED COMMON ELEMENTS.  
 EACH CHANGE IS A COMMON ELEMENT UNLESS ASSIGNED TO A PARTICULAR UNIT, AT WHICH TIME THE CHANGE BECOMES A UNIT ELEMENT.  
 ALL IMPROVEMENTS OUTSIDE OF THE UNITS AND NOT LABELED LIMITED COMMON ELEMENTS ARE COMMON ELEMENTS.

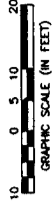

BUILDING 5  
 FLOOR PLANS & ELEVATIONS  
 SHEET 8 OF 35

LAND SURVEYING DIVISION OF  
**John R. Webb & Associates, Inc.**  
 CIVIL & ENVIRONMENTAL CONSULTING ENGINEERS  
 105 S. GARDNER AVENUE  
 WINTER PARK, FLORIDA 32789  
 PH: (407) 822-8322 FAX: (407) 822-8325  
 EMAIL: WEBBENG@AOL.COM

A CONDOMINIUM LYING IN SECTION 36, TOWNSHIP 22 SOUTH, RANGE 28 EAST, ORANGE COUNTY, FLORIDA

EXHIBIT 2' TO DECLARATION OF CONDOMINIUM

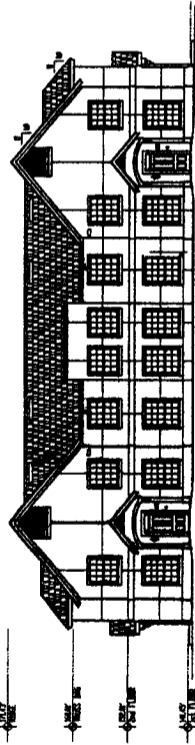

BUILDING 6 - FRONT ELEVATION

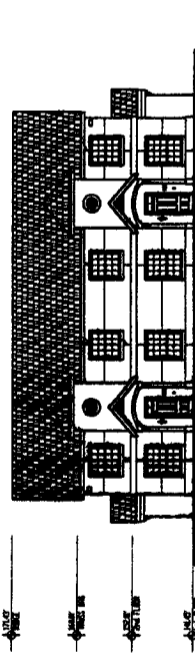

BUILDING 6 - SIDE ELEVATION

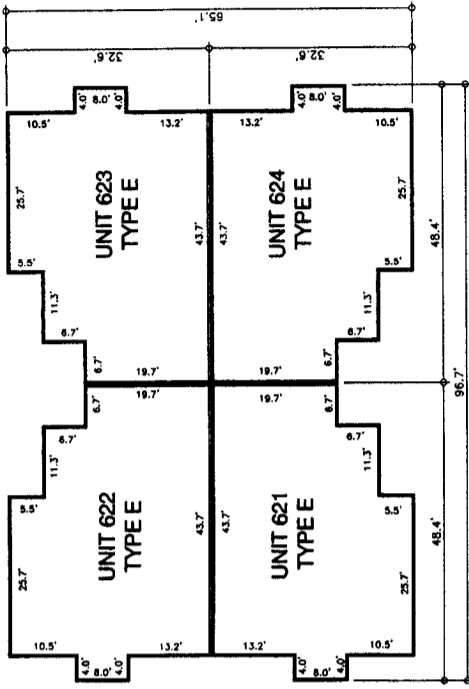

2ND FLOOR

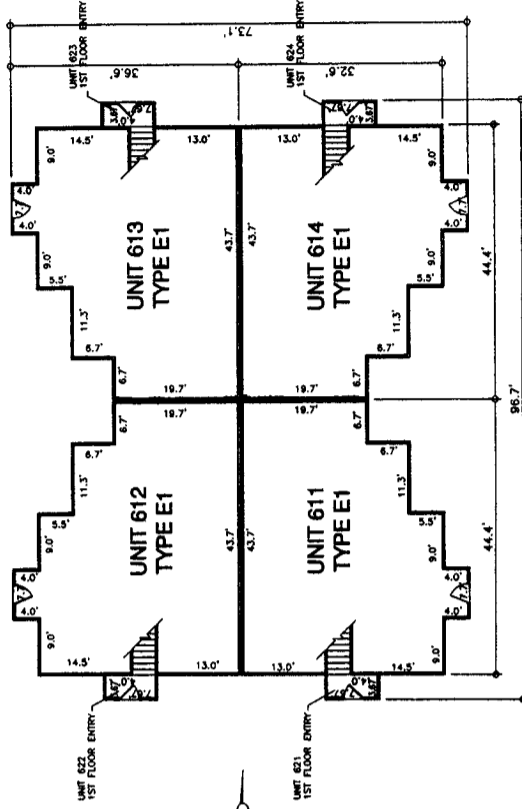

1ST FLOOR

LEGEND:  
 CE COMMON ELEMENT  
 LS LIMITED COMMON ELEMENT  
 ST STORAGE  
 NOTES:  
 ALL DIMENSIONS ARE APPROXIMATED.  
 ALL STORAGE AND PORCHES ARE LIMITED COMMON ELEMENTS.  
 EACH CHANGE IS A COMMON ELEMENT UNLESS ASSIGNED TO A PARTICULAR UNIT.  
 UNITS ASSIGNED TO A PARTICULAR UNIT, UNLESS OTHERWISE SPECIFIED, ARE LIMITED COMMON ELEMENTS OF THE UNIT TO WHICH IT IS ASSIGNED.  
 ALL IMPROVEMENTS OUTSIDE OF THE UNITS AND NOT LABELED LIMITED COMMON ELEMENTS ARE COMMON ELEMENTS.



LAND SURVEYING BRANCH OF  
**John H. Webb & Associates, Inc.**  
 CIVIL & ENVIRONMENTAL ENGINEERS  
 625 S. DELAWARE STREET  
 WINTER PARK, FLORIDA 32789  
 PH: (407) 622-8322 FAX: (407) 622-8325  
 EMAIL: WEBB@WVAD.COM

A CONDOMINIUM LYING IN SECTION 36, TOWNSHIP 22 SOUTH, RANGE 28 EAST, ORANGE COUNTY, FLORIDA

EXHIBIT 2' TO DECLARATION OF CONDOMINIUM

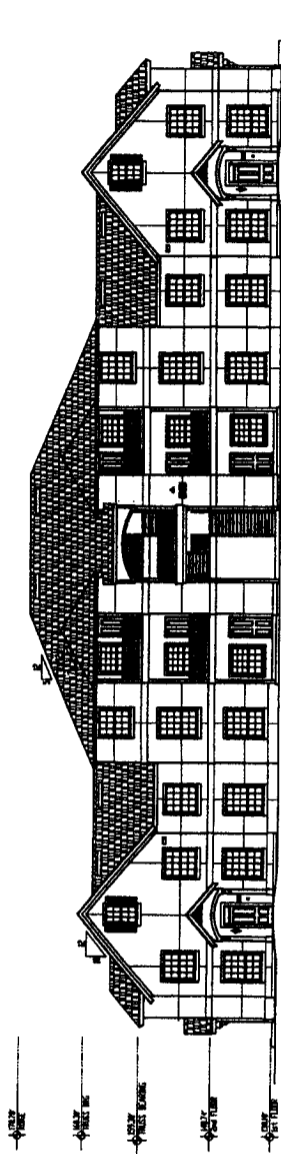

BUILDING 7 - FRONT ELEVATION

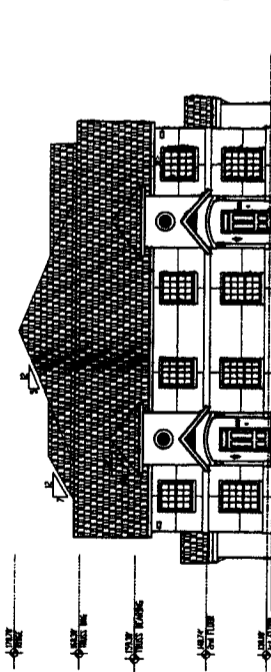

BUILDING 7 - SIDE ELEVATION

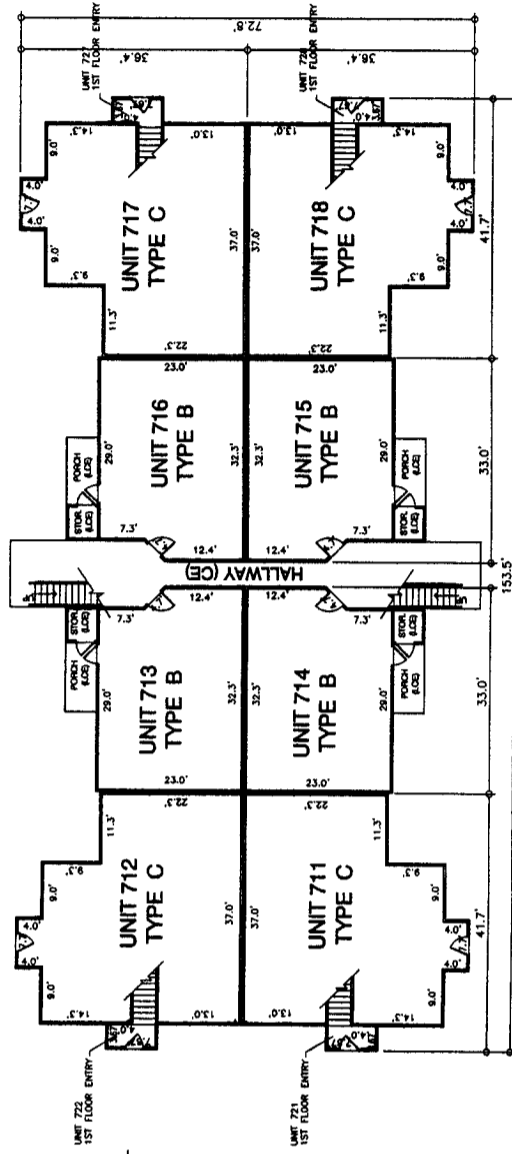

1ST FLOOR

LEGEND:  
 CE COMMON ELEMENT  
 L.C. LIMITED COMMON ELEMENT  
 S.P. STORAGE

NOTES:  
 ALL DIMENSIONS ARE APPROXIMATED.  
 ALL STORAGE AND PORCHES ARE LIMITED COMMON ELEMENTS.  
 EACH GARAGE IS A COMMON ELEMENT AND IS TO BE ASSIGNED TO THE UNIT AT WHICH THE TO PLACED GARAGE. LIMITED COMMON ELEMENT OF THE UNIT TO WHICH IT IS ASSIGNED.  
 ALL IMPROVEMENTS OUTSIDE OF THE UNIT ARE TO BE COMMON ELEMENTS.



LAND SURVEYING DIVISION OF  
**John B. Webb & Associates, Inc.**  
 CIVIL & ENVIRONMENTAL CONSULTING ENGINEERS  
 525 S. DOWNING DRIVE  
 WINTER PARK, FLORIDA 32789  
 PH: (407) 822-8322 FAX: (407) 822-8325  
 EMAIL: WEBB@JWB.COM

THE FOUNTAINS AT METRO WEST, A CONDOMINIUM

A CONDOMINIUM LYING IN SECTION 36, TOWNSHIP 22 SOUTH, RANGE 28 EAST, ORANGE COUNTY, FLORIDA

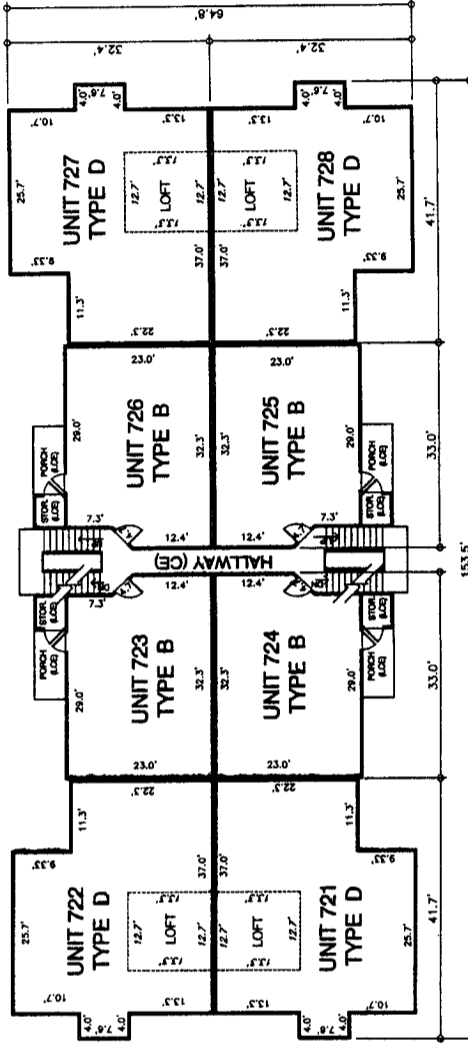
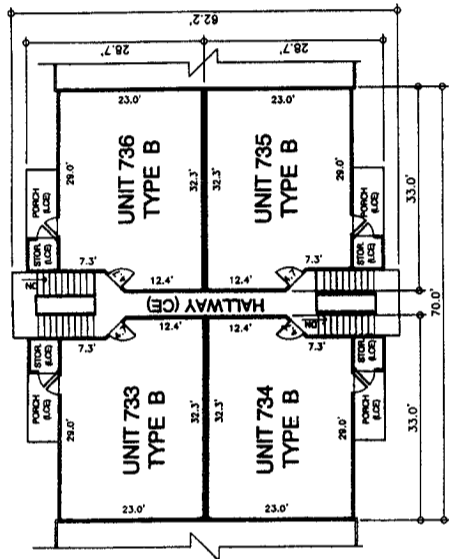

**LEGEND:**  
 CE COMMON ELEMENT  
 STOR. STORAGE  
 CE COMMON ELEMENT  
 STOR. STORAGE

**NOTES:**  
 ALL DIMENSIONS ARE APPROXIMATED.  
 ALL STORAGE AND PORCHES ARE LIMITED COMMON ELEMENTS.  
 EACH CHANGE IS A COMMON ELEMENT UNLESS SPECIFICALLY NOTED OTHERWISE. EACH UNIT, ASSIGNED TO A PARTICULAR UNIT, IS ASSIGNED TO A PARTICULAR LIMITED COMMON ELEMENT OF THE UNIT TO WHICH IT IS ASSIGNED.  
 ALL IMPROVEMENTS OUTSIDE OF THE UNIT ARE LIMITED COMMON ELEMENTS AND NOT LABELED LIMITED COMMON ELEMENTS ARE COMMON ELEMENTS.

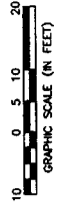

LAND SURVEYING DIVISION OF  
**John B. Webb & Associates, Inc.**  
 CIVIL & ENVIRONMENTAL CONSULTING ENGINEERS  
 523 S. DENNING DRIVE  
 WINTER PARK, FLORIDA 32789  
 PH: (407) 822-9322 FAX: (407) 822-9325  
 EMAIL: WEBBENG@aol.com

# THE FOUNTAINS AT METRO WEST, A CONDOMINIUM

A CONDOMINIUM LYING IN SECTION 36, TOWNSHIP 22 SOUTH, RANGE 28 EAST, ORANGE COUNTY, FLORIDA

EXHIBIT 2<sup>nd</sup> TO DECLARATION OF CONDOMINIUM

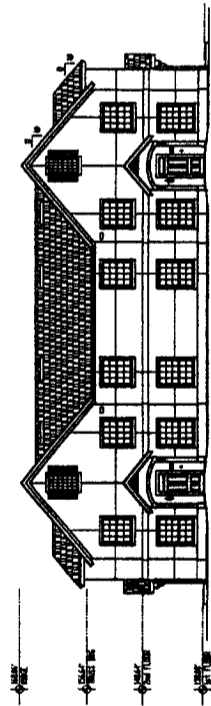

BUILDING 8 - FRONT ELEVATION

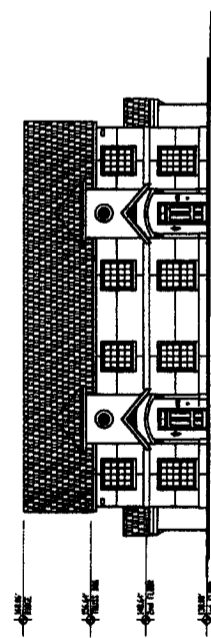

BUILDING 8 - SIDE ELEVATION

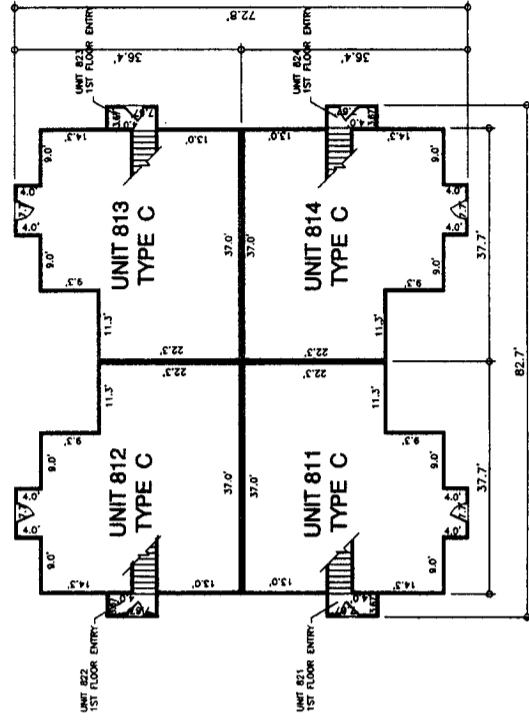
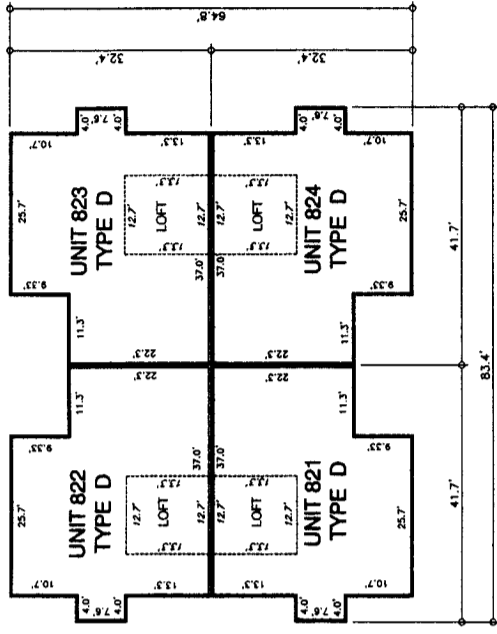

LEGEND:  
 CE COMMON ELEMENT  
 OC OFFICE COMMON ELEMENT  
 STOR. STORAGE

NOTES:  
 ALL DIMENSIONS ARE APPROXIMATED.  
 ALL STORAGE AND PORCHES ARE LIMITED COMMON ELEMENTS.  
 EACH GARAGE IS A COMMON ELEMENT.  
 ALL IMPROVEMENTS OUTSIDE OF THE UNIT ARE LIMITED COMMON ELEMENTS.  
 ALL IMPROVEMENTS OUTSIDE OF THE UNIT ARE LIMITED COMMON ELEMENTS.

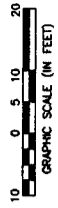

LAND SURVEYING DIVISION OF  
**John B. Webb & Associates, Inc.**  
 CIVIL & ENVIRONMENTAL CONSULTING ENGINEERS  
 525 S. DEWING DRIVE  
 WINTER PARK, FLORIDA 32789  
 PH: (407) 822-4322 FAX: (407) 822-4325  
 EMAIL: WEBB@WEBBANDASSOCIATES.COM

# THE FOUNTAINS AT METRO WEST, A CONDOMINIUM

A CONDOMINIUM LYING IN SECTION 36, TOWNSHIP 22 SOUTH, RANGE 28 EAST, ORANGE COUNTY, FLORIDA

EXHIBIT "2" TO DECLARATION OF CONDOMINIUM

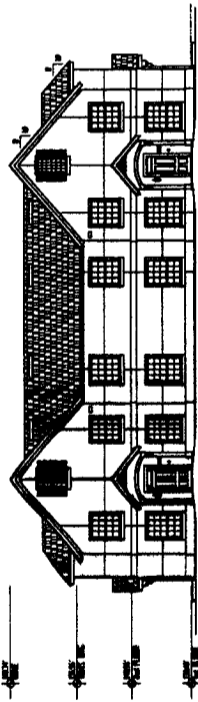

BUILDING 9 - FRONT ELEVATION

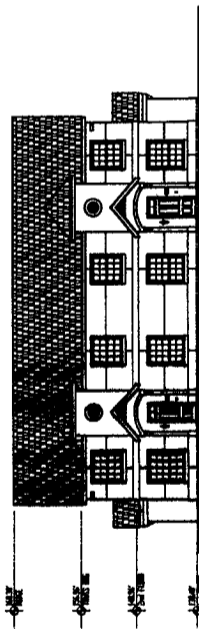

BUILDING 9 - SIDE ELEVATION

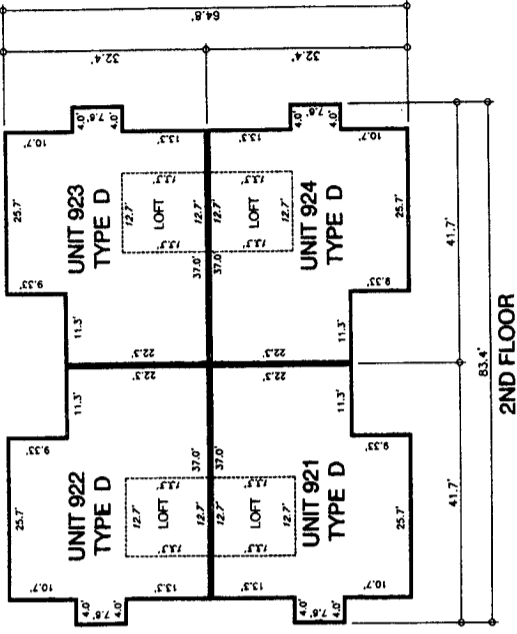

2ND FLOOR

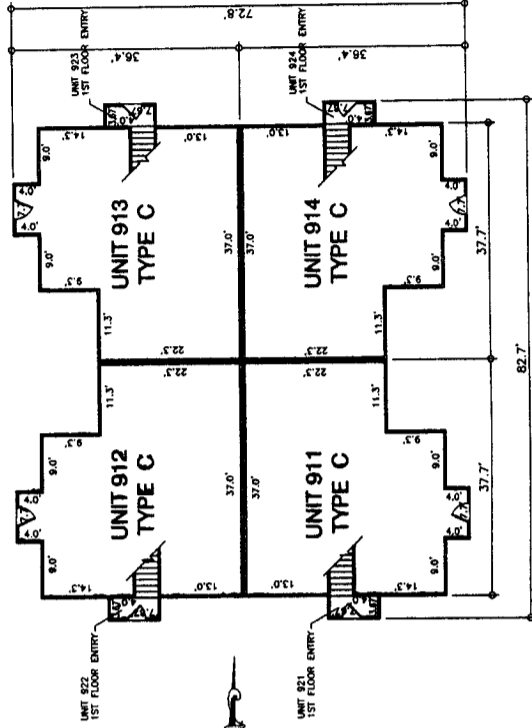

1ST FLOOR

LEGEND:  
 COMMON ELEMENT  
 UNIT COMMON ELEMENT  
 STORAGE

NOTES:  
 ALL DIMENSIONS ARE APPROXIMATED.  
 ALL STORAGE AND PORCHES ARE LIMITED COMMON ELEMENTS.  
 EACH GARAGE IS A COMMON ELEMENT AND IS ASSIGNED TO THE UNIT AT WHICH TIME THE GARAGE BECOMES A LIMITED COMMON ELEMENT OF THE UNIT TO WHICH IT IS ASSIGNED.  
 ALL UNITS ARE UNITS AS SHOWN ON THE COMMON ELEMENTS ARE COMMON ELEMENTS.

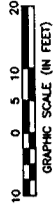

LAWYER  
 John R. Webb & Associates, Inc.  
 CIVIL & ENVIRONMENTAL CONSULTING ENGINEERS  
 255 S. DEERBARK BLVD.  
 WINTER PARK, FLORIDA 32789  
 PHONE: (407) 939-1325  
 FAX: (407) 939-1325  
 EMAIL: WEBB@WEBB-LLP.COM



# THE FOUNTAINS AT METRO WEST, A CONDOMINIUM

A CONDOMINIUM LYING IN SECTION 36, TOWNSHIP 22 SOUTH, RANGE 28 EAST, ORANGE COUNTY, FLORIDA

CONDOMINIUM BOOK PAGE

EXHIBIT 2' TO DECLARATION OF CONDOMINIUM

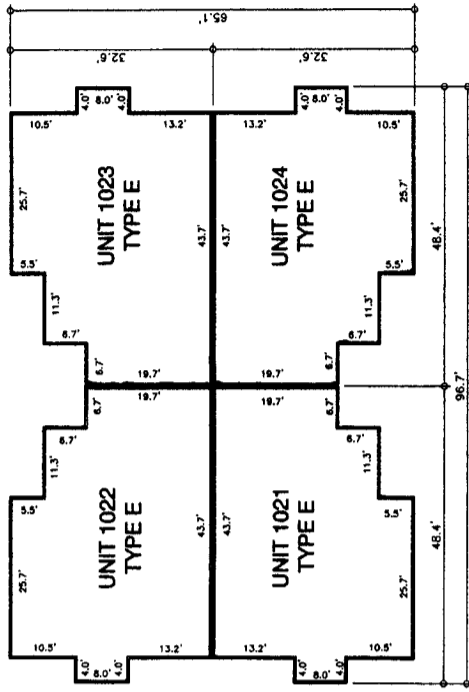

2ND FLOOR

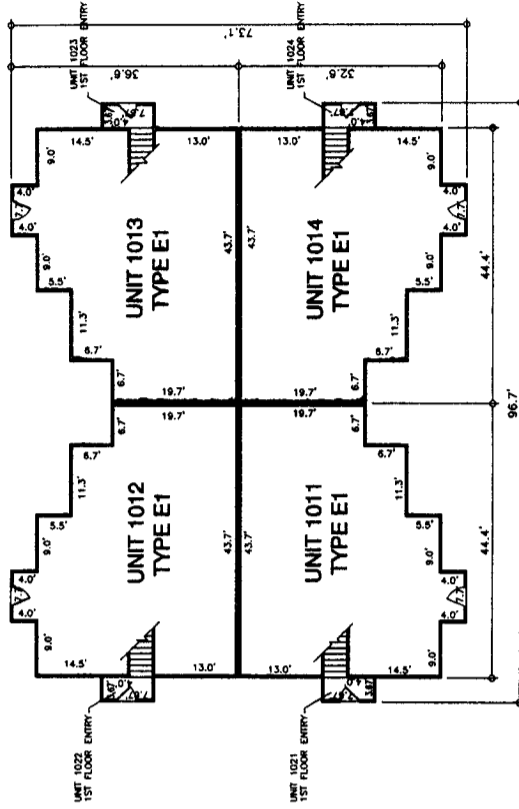

1ST FLOOR

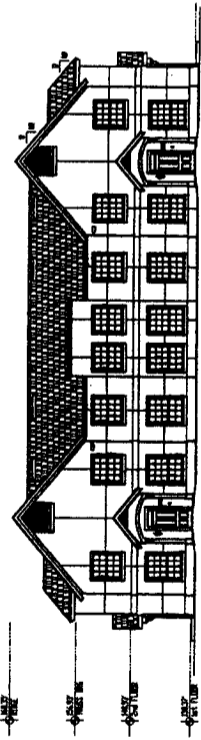

BUILDING 10 - FRONT ELEVATION

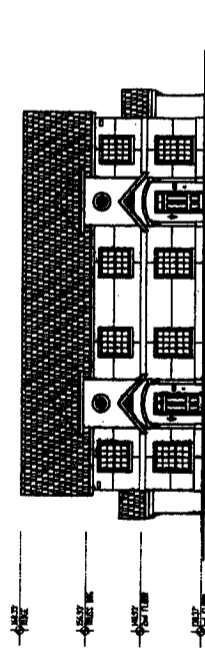

BUILDING 10 - SIDE ELEVATION

LEGEND:  
 COMMON ELEMENT  
 UNIT  
 LIMITED COMMON ELEMENT  
 STOR.  
 STORAGE

NOTES:  
 ALL DIMENSIONS ARE APPROXIMATED.  
 UNIT DIMENSIONS AND FINISHES ARE LIMITED COMMON ELEMENTS.  
 COMMON ELEMENTS ARE APPROXIMATED.  
 FINISHES AND FINISHES ARE LIMITED COMMON ELEMENTS.  
 EACH GARAGE IS A COMMON ELEMENT. GARAGE IS ASSIGNED TO A PARTICULAR UNIT. AT WHICH TIME THE GARAGE BECOMES A LIMITED COMMON ELEMENT OF THE UNIT TO WHICH IT IS ASSIGNED.  
 ALL APPROXIMATIONS OUTSIDE OF THE UNITS AND NOT LABELED LIMITED COMMON ELEMENTS ARE COMMON ELEMENTS.



BUILDING 10  
 FLOOR PLANS & ELEVATIONS  
 SHEET 14 OF 33

LAND SURVEYING DIVISION OF  
**Solan R. Welch & Associates, Inc.**  
 CIVIL & ENVIRONMENTAL CONSULTING ENGINEERS  
 825 S. USHER DRIVE  
 WINTER PARK, FLORIDA 32789  
 PH: (407) 822-4322 FAX: (407) 822-4325  
 EMAIL: WEBS@RWAL.COM

# THE FOUNTAINS AT METRO WEST, A CONDOMINIUM

A CONDOMINIUM LYING IN SECTION 36, TOWNSHIP 22 SOUTH, RANGE 28 EAST, ORANGE COUNTY, FLORIDA

CONDOMINIUM BOOK PAGE

EXHIBIT 2<sup>nd</sup> TO DECLARATION OF CONDOMINIUM

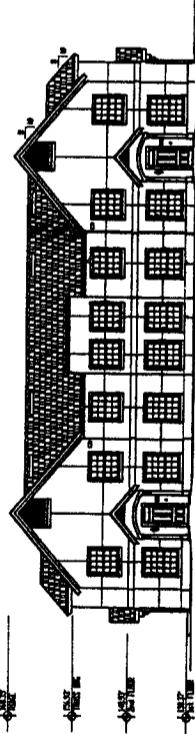

BUILDING 11 - FRONT ELEVATION

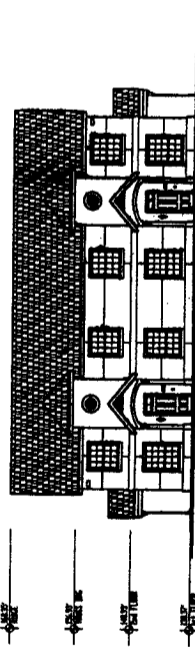

BUILDING 11 - SIDE ELEVATION

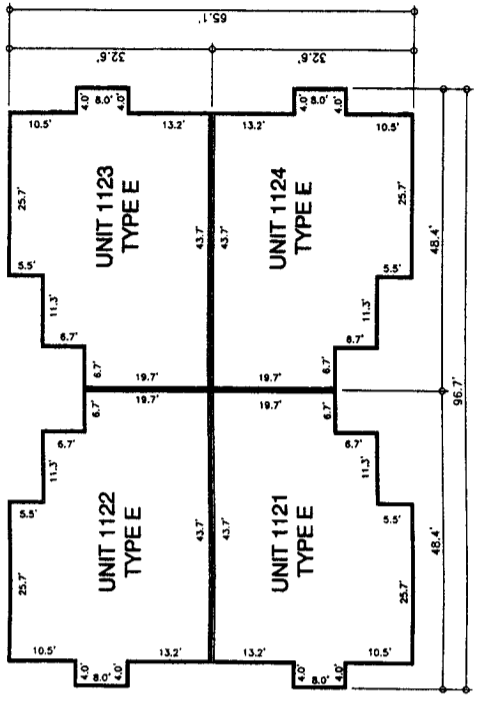

2ND FLOOR

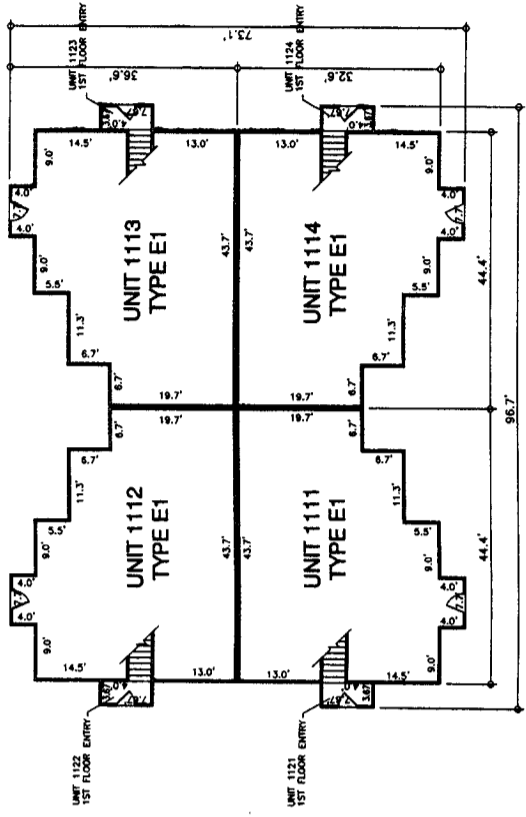

1ST FLOOR

**LEGEND:**  
 CE COMMON ELEMENT  
 LCE LIMITED COMMON ELEMENT  
 STOR. STORAGE

**NOTES:**  
 ALL DIMENSIONS ARE APPROXIMATE.  
 ALL STAIRS AND RAMPWAYS ARE LIMITED COMMON ELEMENTS.  
 EACH GARAGE IS A COMMON ELEMENT WITH ASSIGNED TO A PARTICULAR UNIT. AT WHICH TIME THE GARAGE BECOMES A LIMITED COMMON ELEMENT OF THE UNIT TO WHICH IT IS ASSIGNED.  
 ALL IMPROVEMENTS OUTSIDE OF THE UNITS AND NOT LABELED LIMITED COMMON ELEMENTS ARE COMMON ELEMENTS.

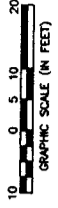

BUILDING 11  
 FLOOR PLANS & ELEVATIONS  
 SHEET 15 OF 33

LAWD SURVEYING DIVISION OF  
**John A. Webb & Associates, Inc.**  
 CIVIL & ENVIRONMENTAL CONSULTING ENGINEERS  
 1000 W. UNIVERSITY BLVD.  
 SUITE 2000  
 WINTER PARK, FLORIDA 32789  
 PH: (407) 822-3322 FAX: (407) 822-8325  
 EMAIL: WEBB@WEBBVA.COM

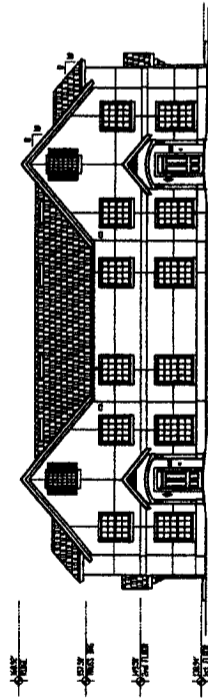

BUILDING 12 - FRONT ELEVATION

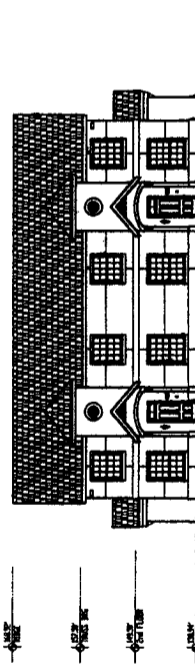

BUILDING 12 - SIDE ELEVATION

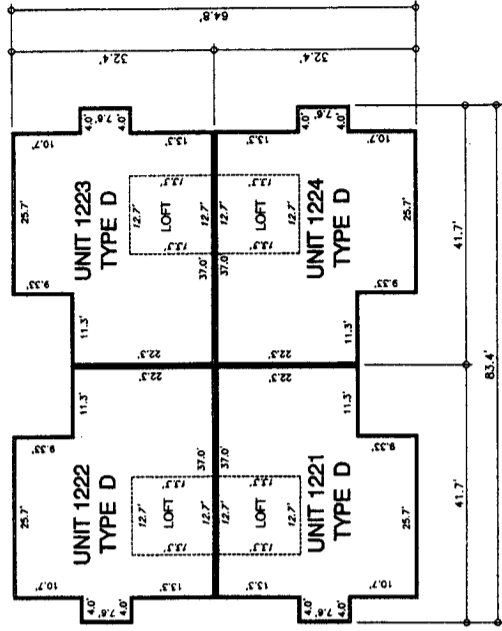

2ND FLOOR

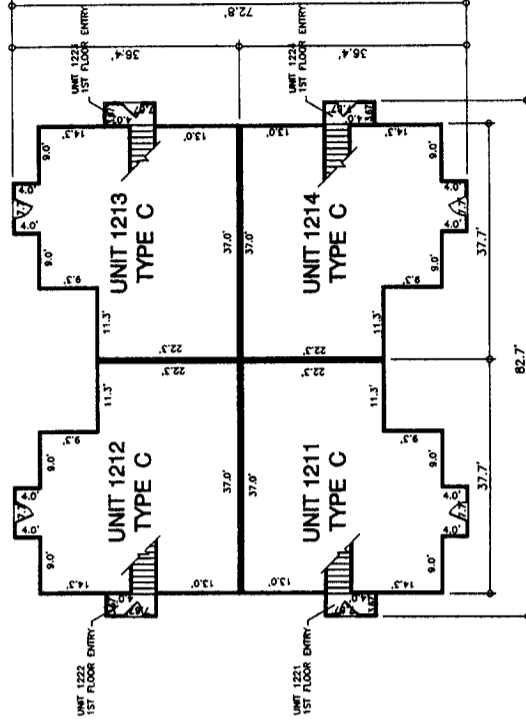

1ST FLOOR

LEGEND:  
 CE COMMON ELEMENT  
 CE COMMON ELEMENT  
 STOR. STORAGE

NOTES:  
 ALL DIMENSIONS ARE APPROXIMATED.  
 UNITS AND COMMON ELEMENTS ARE LIMITED TO THE FLOORS INDICATED.  
 UNITS ASSIGNED TO A PARTICULAR UNIT, AT WHICH TIME THE DAMAGE BECOMES THE RESPONSIBILITY OF THE UNIT TO WHICH IT IS ASSIGNED.  
 ALL IMPROVEMENTS OUTSIDE OF THE UNITS AND NOT LABELED LIMITED COMMON ELEMENTS ARE COMMON ELEMENTS.

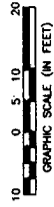

LAND SURVEYING DIVISION OF  
**John B. Webb & Associates, Inc.**  
 CIVIL & ENVIRONMENTAL CONSULTING ENGINEERS  
 1500 WINTER PARK BLVD., SUITE 200  
 WINTER PARK, FLORIDA 32789  
 PH: (407) 822-4322 FAX: (407) 822-9325  
 EMAIL: WEBB@WEBB-MAIL.COM

# THE FOUNTAINS AT METRO WEST, A CONDOMINIUM

A CONDOMINIUM LYING IN SECTION 36, TOWNSHIP 22 SOUTH, RANGE 28 EAST, ORANGE COUNTY, FLORIDA

CONDOMINIUM BOOK PAGE

EXHIBIT 2<sup>nd</sup> TO DECLARATION OF CONDOMINIUM

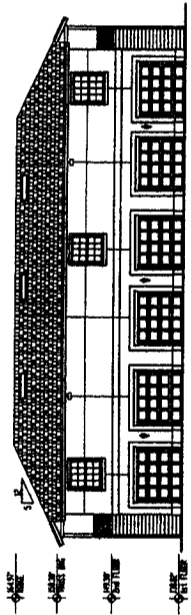

BUILDING 13 - FRONT ELEVATION

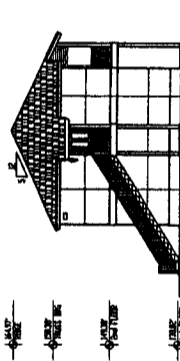

BUILDING 13 - SIDE ELEVATION

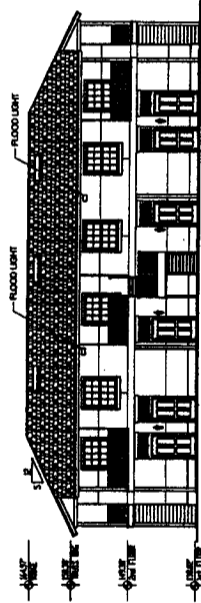

BUILDING 13 - REAR ELEVATION

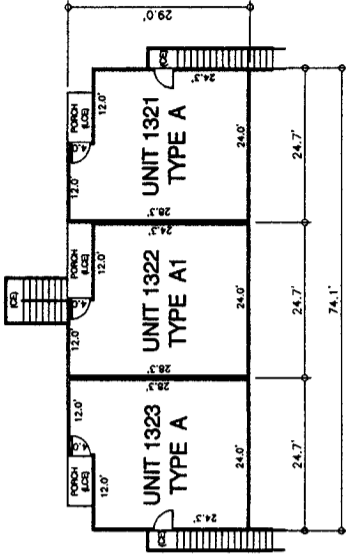

2ND FLOOR

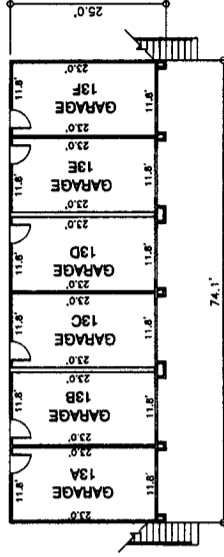

1ST FLOOR

LEGEND:  
 CE COMMON ELEMENT  
 LCE LIMITED COMMON ELEMENT  
 STOR. STORAGE

NOTES:  
 ALL DIMENSIONS ARE APPROXIMATED.  
 ALL STORAGE AND PORCHES ARE LIMITED COMMON ELEMENTS.

EACH GARAGE IS A COMMON ELEMENT UNIT ASSIGNED TO A PARTICULAR UNIT. UNIT ASSIGNED TO A PARTICULAR UNIT, LIMITED COMMON ELEMENTS, A LIMITED COMMON ELEMENT OF THE UNIT TO WHICH IT IS ASSIGNED.

ALL IMPROVEMENTS OUTSIDE OF THE UNITS AND NOT LABELED LIMITED COMMON ELEMENTS ARE COMMON ELEMENTS.

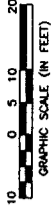

BUILDING 13  
 FLOOR PLANS & ELEVATIONS  
 SHEET 17 OF 33

LAND SURVEYING DIVISION OF  
**John R. Webb & Associates, Inc.**  
 CIVIL & ENVIRONMENTAL CONSULTING ENGINEERS  
 925 S. DICKENS DRIVE  
 WINTER PARK, FLORIDA 32789  
 PH: (407) 948-7822 FAX: (407) 922-0325  
 EMAIL: JWEBB@JWAC.COM

# THE FOUNTAINS AT METRO WEST, A CONDOMINIUM

A CONDOMINIUM LYING IN SECTION 96, TOWNSHIP 22 SOUTH, RANGE 28 EAST, ORANGE COUNTY, FLORIDA

EXHIBIT 2' TO DECLARATION OF CONDOMINIUM

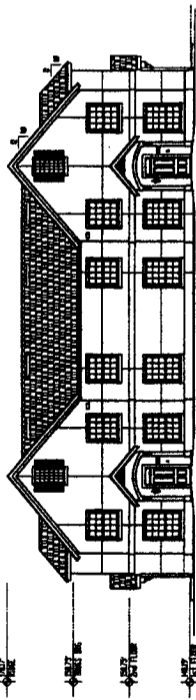

BUILDING 14 - FRONT ELEVATION

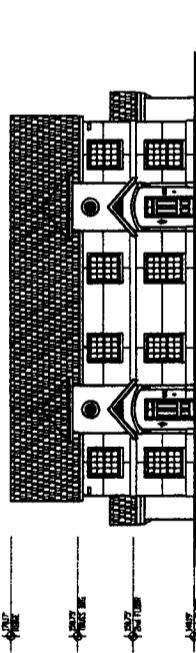

BUILDING 14 - SIDE ELEVATION

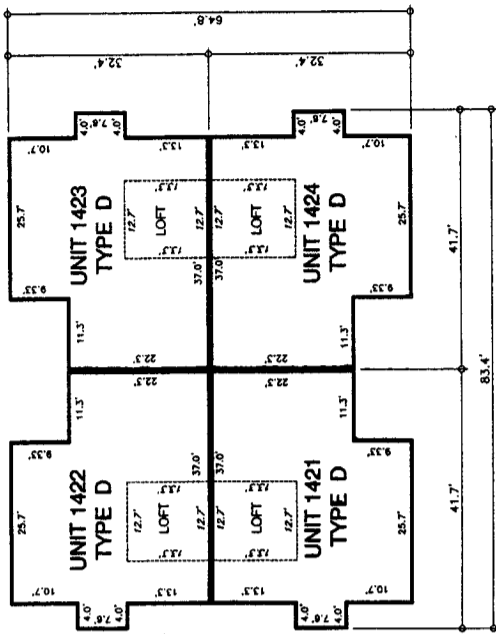

2ND FLOOR

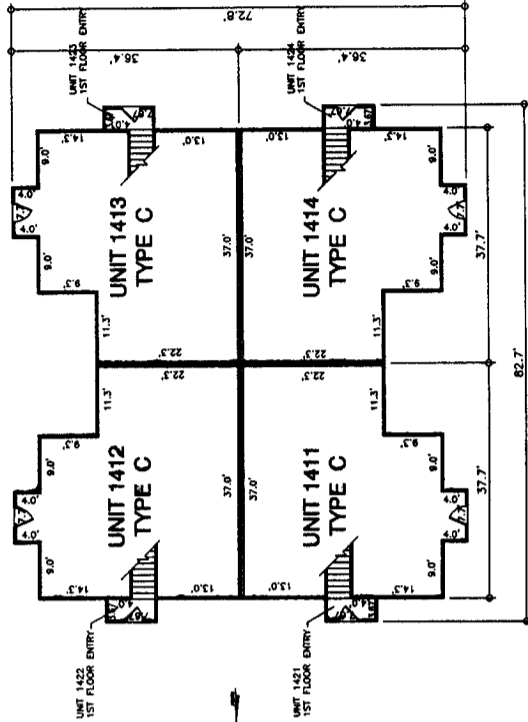

1ST FLOOR

LEGEND:  
 CE COMMON ELEMENT  
 LCE LIMITED COMMON ELEMENT  
 STOR. STORAGE

NOTES:  
 ALL DIMENSIONS ARE APPROXIMATED.  
 ALL STORAGE AND PORCHES ARE LIMITED COMMON ELEMENTS.  
 EACH GARAGE IS A COMMON ELEMENT.  
 UNIT 1422 IS A COMMON ELEMENT UNIT ASSIGNED TO THE COMMON ELEMENT LIMITED COMMON ELEMENT OF THE UNIT TO WHICH IT IS ASSIGNED.  
 ALL IMPROVEMENTS OUTSIDE OF THE UNIT ARE LIMITED COMMON ELEMENTS. COMMON ELEMENTS ARE COMMON ELEMENTS.

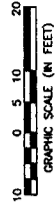

BUILDING 14  
 FLOOR PLANS & ELEVATIONS  
 SHEET 18 OF 33

LAND SURVEYING DIVISION OF  
**John R. Webb & Associates, Inc.**  
 CIVIL & ENVIRONMENTAL CONSULTING ENGINEERS  
 925 S. DOWNING DRIVE  
 WINTER PARK, FLORIDA 32789  
 PH: (407) 822-9322 FAX: (407) 822-9325  
 EMAIL: WEBBER@MAIL.COM

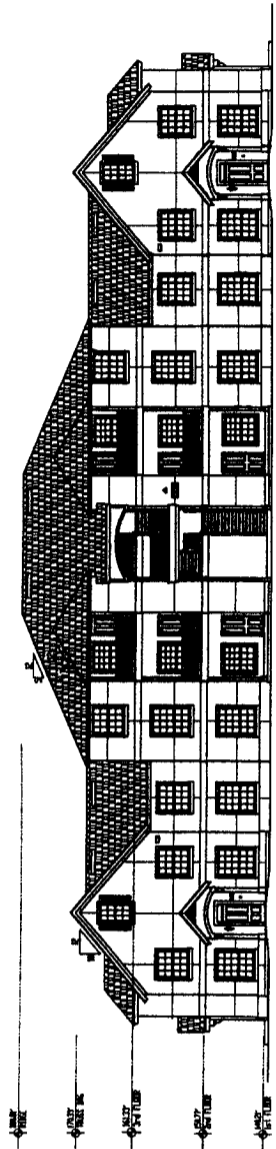

BUILDING 15 - FRONT ELEVATION

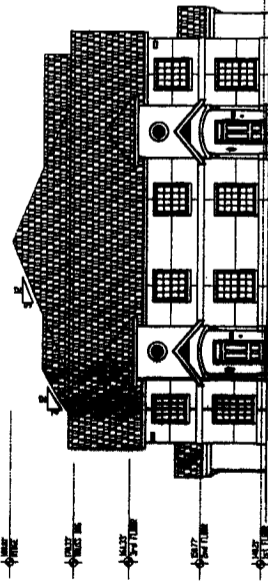

BUILDING 15 - SIDE ELEVATION

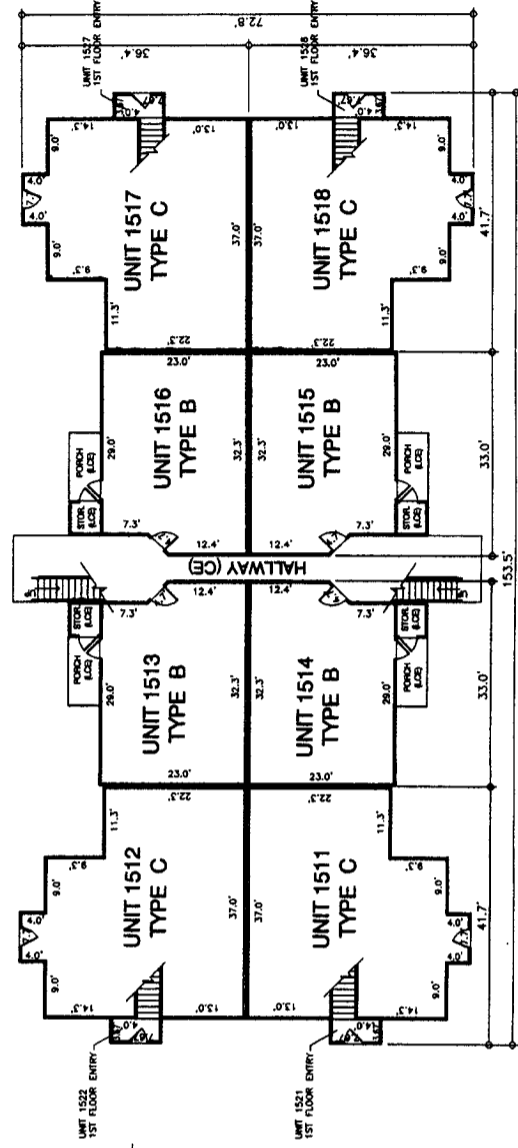

1ST FLOOR

LEGEND:  
 CE COMMON ELEMENT  
 LCE LIMITED COMMON ELEMENT  
 STOR. STORAGE

NOTES:  
 ALL DIMENSIONS ARE APPROXIMATED.  
 ALL STORAGE AND PORCHES ARE LIMITED COMMON ELEMENTS.  
 EACH GARAGE IS A COMMON ELEMENT. THE GARAGE BECOMES A LIMITED COMMON ELEMENT AT WHICH TIME THE GARAGE BECOMES A LIMITED COMMON ELEMENT TO THE CHANGING ASSIGMENT TO THE CHANGING ASSIGMENT.  
 ALL UNLABELED PORCHES AS THE UNITS AND NOT LABELED LIMITED COMMON ELEMENTS ARE COMMON ELEMENTS.

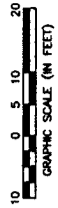

LAW, ARCHITECTURE, ENGINEERING  
**John R. White & Associates, Inc.**  
 CIVIL & ENVIRONMENTAL ENGINEERING ENGINEERS  
 925 S. DORRIS DRIVE  
 WINTER PARK, FLORIDA 32789  
 PH: (407) 622-8322 FAX: (407) 622-8325  
 EMAIL: JRW@JRWENGINEERS.COM

# THE FOUNTAINS AT METRO WEST, A CONDOMINIUM

A CONDOMINIUM LYING IN SECTION 36, TOWNSHIP 22 SOUTH, RANGE 28 EAST, ORANGE COUNTY, FLORIDA

EXHIBIT 2\* TO DECLARATION OF CONDOMINIUM

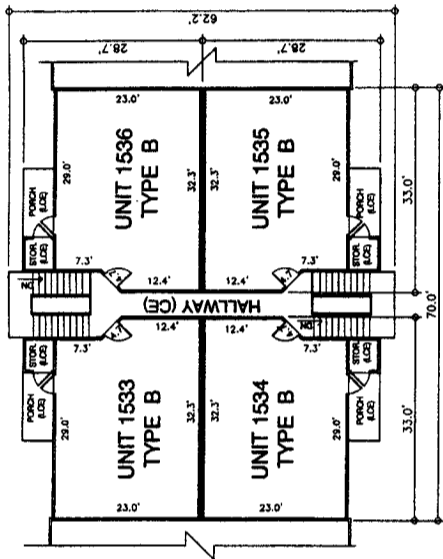

3RD FLOOR

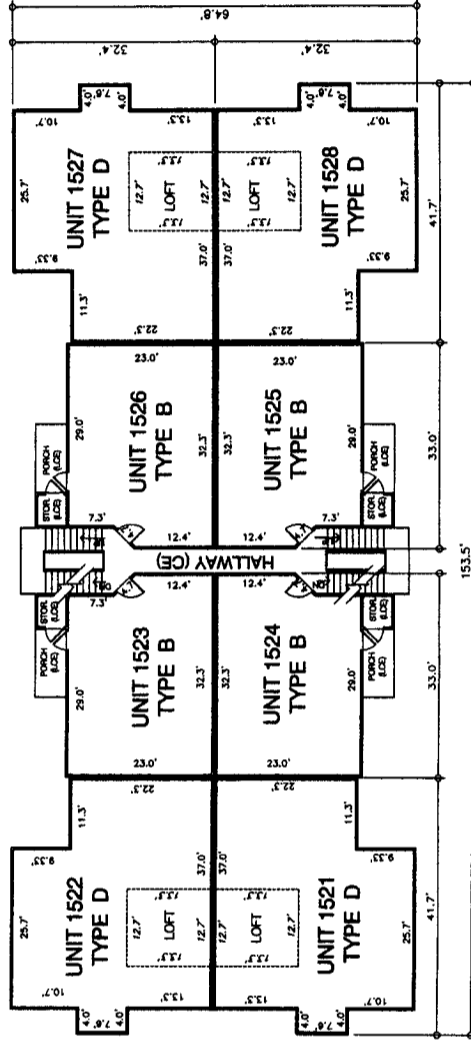

2ND FLOOR

**LEGEND:**  
 COMMON ELEMENT  
 LIMITED COMMON ELEMENT  
 LCE  
 STOR.  
 STORAGE

**NOTES:**  
 ALL DIMENSIONS ARE APPROXIMATED.  
 ALL STORAGE AND PORCHES ARE LIMITED COMMON ELEMENTS.  
 EACH CHANGE IS A COMMON ELEMENT UNLESS SPECIFICALLY NOTED OTHERWISE.  
 UNITS ASSIGNED TO A PARTICULAR UNIT TYPE ARE LIMITED COMMON ELEMENTS OF THE UNIT TO WHICH IT IS ASSIGNED.  
 ALL IMPROVEMENTS OUTSIDE OF THE UNIT ARE LIMITED COMMON ELEMENTS AND COMMON ELEMENTS ARE COMMON ELEMENTS.



**BUILDING 15**  
**FLOOR PLANS**  
 SHEET 20 OF 33

LAND SURVEYING DIVISION OF  
**John B. Webb & Associates, Inc.**  
 CIVIL & ENVIRONMENTAL CONSULTING ENGINEERS  
 925 S. DENNING DRIVE  
 WINTER PARK, FLORIDA 32789  
 PH: (407) 822-8322 FAX: (407) 822-9325  
 EMAIL: WEBB@WEBBAC.COM

# THE FOUNTAINS AT METRO WEST, A CONDOMINIUM

A CONDOMINIUM LYING IN SECTION 36, TOWNSHIP 22 SOUTH, RANGE 28 EAST, ORANGE COUNTY, FLORIDA

CONDOMINIUM BOOK PAGE

EXHIBIT "2" TO DECLARATION OF CONDOMINIUM

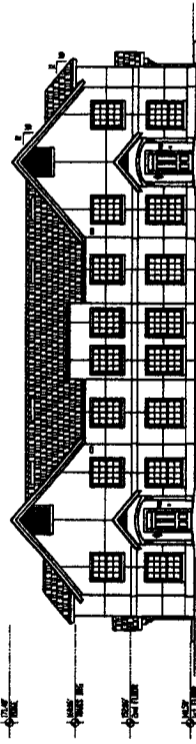

BUILDING 16 - FRONT ELEVATION

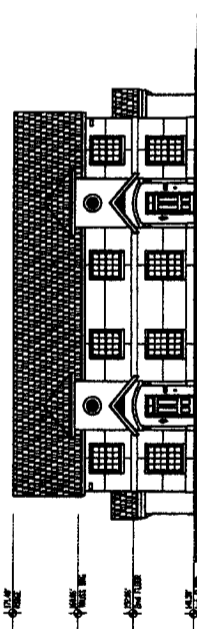

BUILDING 16 - SIDE ELEVATION

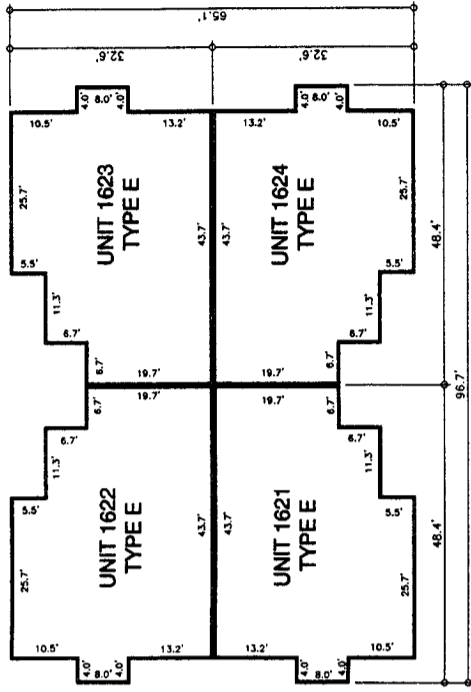

2ND FLOOR

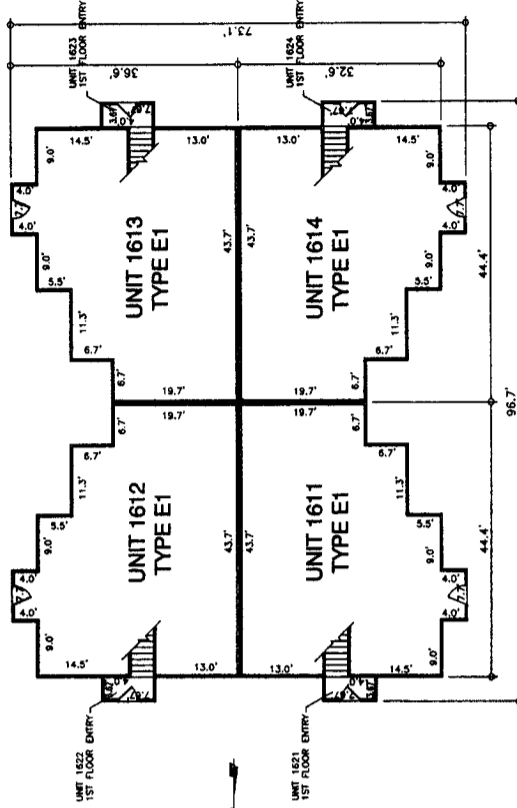

1ST FLOOR

LEGEND:  
 COMMON ELEMENT  
 LIMITED COMMON ELEMENT  
 U.C.E.  
 STORAGE

NOTES:

ALL DIMENSIONS ARE APPROXIMATED.  
 ALL STORAGE AND PORCHES ARE LIMITED COMMON ELEMENTS.  
 EACH GARAGE IS A COMMON ELEMENT.  
 EACH GARAGE IS ASSIGNED TO A PARTICULAR UNIT.  
 THE UNIT ASSIGNED TO A PARTICULAR UNIT IS LIMITED COMMON ELEMENT OF THE UNIT TO WHICH IT IS ASSIGNED.  
 ALL IMPROVEMENTS OUTSIDE OF THE CONDOMINIUM ARE NOT INCLUDED IN THE COMMON ELEMENTS.



BUILDING 16  
 FLOOR PLANS & ELEVATIONS  
 SHEET 21 OF 33

LAND SURVEYING DIVISION OF  
**John R. Webb & Associates, Inc.**  
 CIVIL & ENVIRONMENTAL CONSULTING ENGINEERS  
 125 S. GARDNER DRIVE  
 WINTER PARK, FLORIDA 32789  
 PH: (407) 822-8320 FAX: (407) 822-8325  
 EMAIL: WEBBENG@AOL.COM



# THE FOUNTAINS AT METRO WEST, A CONDOMINIUM

A CONDOMINIUM LYING IN SECTION 36, TOWNSHIP 22 SOUTH, RANGE 28 EAST, ORANGE COUNTY, FLORIDA

CONDOMINIUM BOOK PAGE

EXHIBIT 2\* TO DECLARATION OF CONDOMINIUM

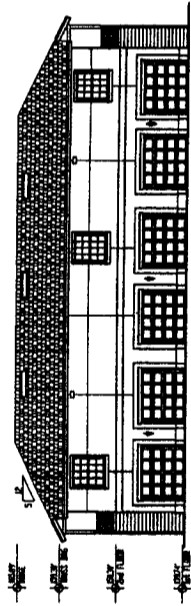

BUILDING 17 - FRONT ELEVATION

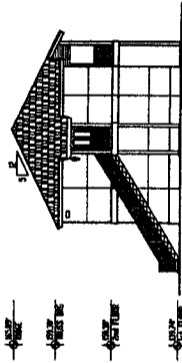

BUILDING 17 - SIDE ELEVATION

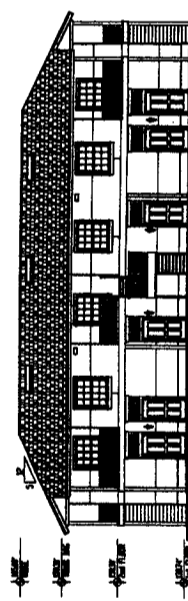

BUILDING 17 - REAR ELEVATION

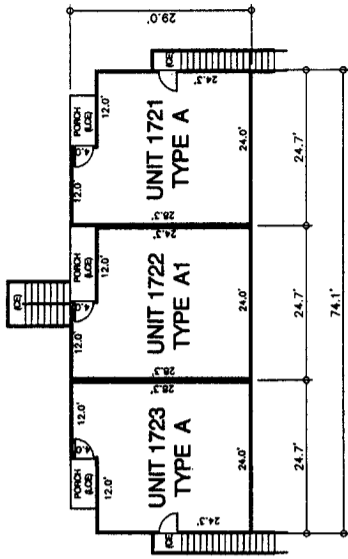

2ND FLOOR

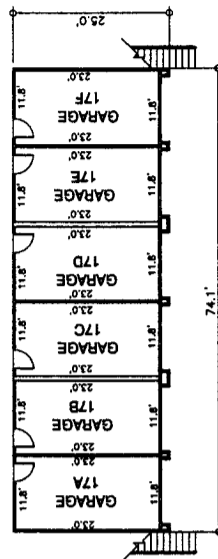

1ST FLOOR

LEGEND:  
 CE COMMON ELEMENT  
 LCE LIMITED COMMON ELEMENT  
 STOR. STORAGE

NOTES:  
 ALL DIMENSIONS ARE APPROXIMATED.  
 ALL STORAGE AND PORCHES ARE LIMITED COMMON ELEMENTS.  
 EACH GARAGE IS A COMMON ELEMENT.  
 EACH GARAGE IS A COMMON ELEMENT UNIT, ASSIGNED TO A PARTICULAR UNIT, LIMITED COMMON ELEMENT OF THE UNIT TO WHICH IT IS ASSIGNED.  
 ALL IMPROVEMENTS OUTSIDE OF THE UNIT ARE LIMITED COMMON ELEMENTS.  
 ALL IMPROVEMENTS INSIDE OF THE UNIT ARE COMMON ELEMENTS.

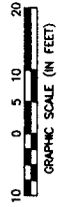

BUILDING 17  
 FLOOR PLANS & ELEVATIONS  
 SHEET 22 OF 33

LAND SURVEYING DIVISION OF  
**John B. Webb & Associates, Inc.**  
 CIVIL & ENVIRONMENTAL CONSULTING ENGINEERS  
 180 S. WASHINGTON BLVD.  
 SUITE 200  
 FT. LAUDERDALE, FL 33301  
 TEL: (954) 575-3325  
 FAX: (954) 575-3325  
 EMAIL: WEBB@WEBB-ASSOCIATES.COM

# THE FOUNTAINS AT METRO WEST, A CONDOMINIUM

A CONDOMINIUM LYING IN SECTION 36, TOWNSHIP 22 SOUTH, RANGE 28 EAST, ORANGE COUNTY, FLORIDA

CONDOMINIUM BOOK PAGE

EXHIBIT 2' TO DECLARATION OF CONDOMINIUM

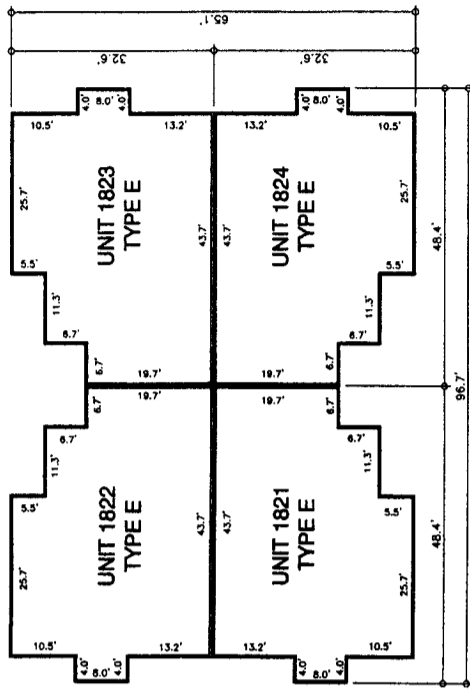

2ND FLOOR

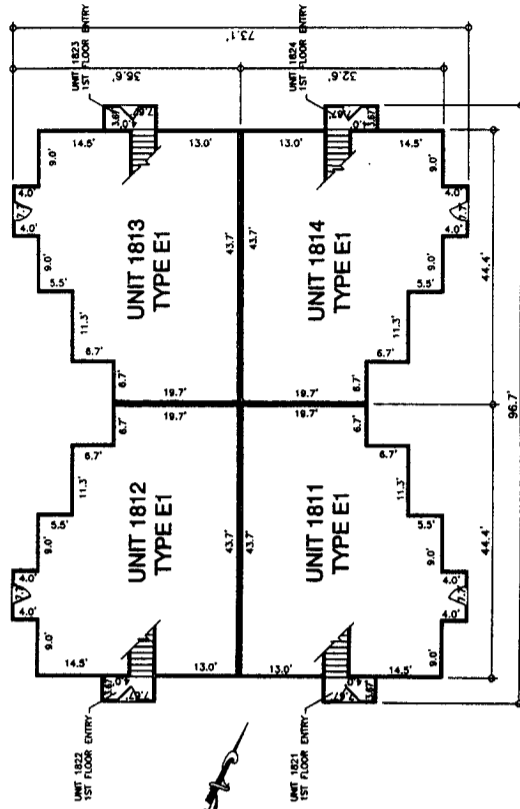

1ST FLOOR

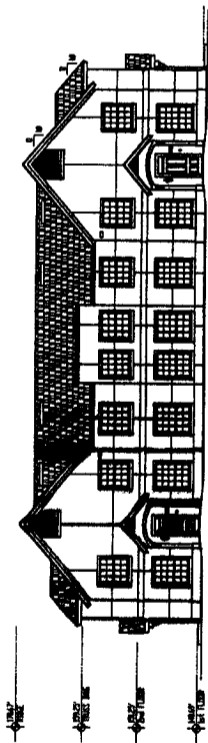

BUILDING 18 - FRONT ELEVATION

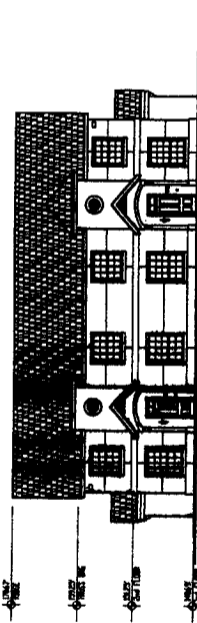

BUILDING 18 - SIDE ELEVATION

LEGEND:  
 CE COMMON ELEMENT  
 CE LIMITED COMMON ELEMENT  
 STOR. STORAGE

NOTES:  
 ALL DIMENSIONS ARE APPROXIMATED.  
 ALL STAIRS AND RAMPWAYS ARE LIMITED COMMON ELEMENTS.  
 EACH CHANGE IS A COMMON ELEMENT WITH ASSIGNED TO A PARTICULAR UNIT, AT WHICH TIME THE CHANGE BECOMES A LIMITED COMMON ELEMENT OF THE UNIT TO WHICH IT IS ASSIGNED.  
 ALL IMPROVEMENTS OUTSIDE OF THE UNITS AND NOT LABELED LIMITED COMMON ELEMENTS ARE COMMON ELEMENTS.

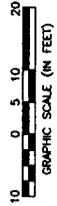

BUILDING 18  
 FLOOR PLANS & ELEVATIONS  
 SHEET 23 OF 33

LAND SURVEYING DIVISION OF  
**John R. Webb & Associates, Inc.**  
 CIVIL & ENVIRONMENTAL CONSULTING ENGINEERS  
 625 S. BERNARD DRIVE  
 MIAMI BEACH, FLORIDA 33133  
 PH: (407) 521-1100 FAX: (407) 521-0325  
 EMAIL: WEBBER@WEBB.COM

# THE FOUNTAINS AT METRO WEST, A CONDOMINIUM

A CONDOMINIUM LYING IN SECTION 36, TOWNSHIP 22 SOUTH, RANGE 28 EAST, ORANGE COUNTY, FLORIDA

EXHIBIT 2\* TO DECLARATION OF CONDOMINIUM

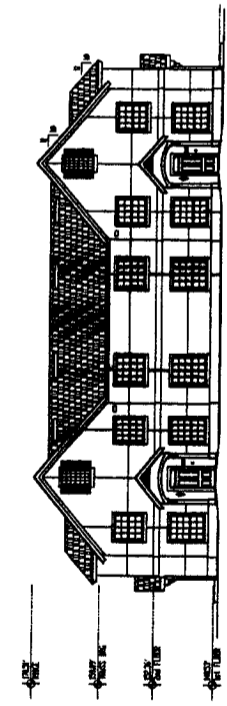
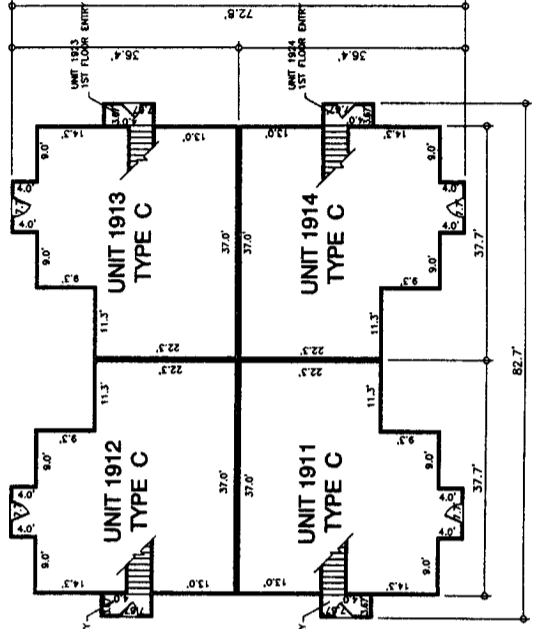
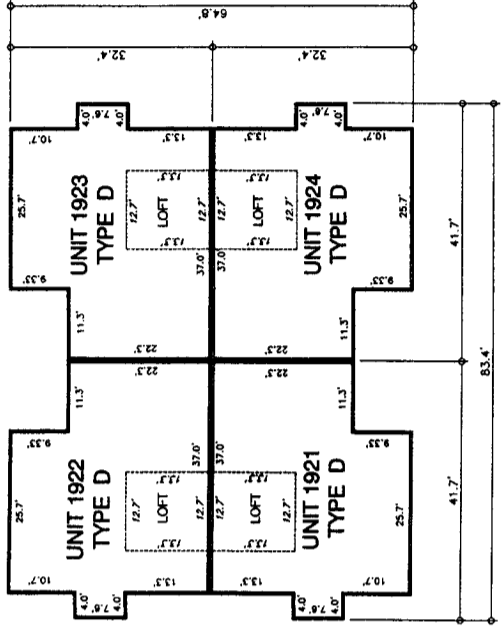

BUILDING 19 - FRONT ELEVATION

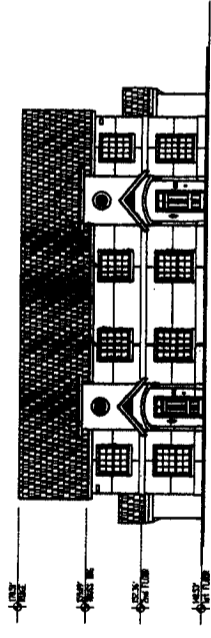

BUILDING 19 - SIDE ELEVATION

**LEGEND:**  
 CE COMMON ELEMENT  
 CE COMMON ELEMENT  
 STOR. STORAGE

**NOTES:**  
 ALL DIMENSIONS ARE APPROXIMATED.  
 ALL STORAGE AND PORCHES ARE LIMITED COMMON ELEMENTS.  
 EACH GARAGE IS A COMMON ELEMENT UNTIL ASSIGNED TO A PARTICULAR UNIT, AT WHICH TIME THE GARAGE BECOMES A PART OF THE COMMON ELEMENTS OF THE UNIT TO WHICH IT IS ASSIGNED.  
 ALL IMPROVEMENTS OUTSIDE OF THE UNITS AND NOT LABELED LIMITED COMMON ELEMENTS ARE COMMON ELEMENTS.

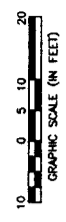

LAND SURVEYING DIVISION OF  
**John R. Webb & Associates, Inc.**  
 CIVIL & ENVIRONMENTAL CONSULTING ENGINEERS  
 9225 S. DENNING DRIVE  
 WINTER PARK, FLORIDA 32789  
 PH: (407) 622-8322 FAX: (407) 622-9325  
 EMAIL: WEBB@RWAG.COM

# THE FOUNTAINS AT METRO WEST, A CONDOMINIUM

A CONDOMINIUM LYING IN SECTION 36, TOWNSHIP 22 SOUTH, RANGE 28 EAST, ORANGE COUNTY, FLORIDA

CONDOMINIUM BOOK PAGE

EXHIBIT 2' TO DECLARATION OF CONDOMINIUM

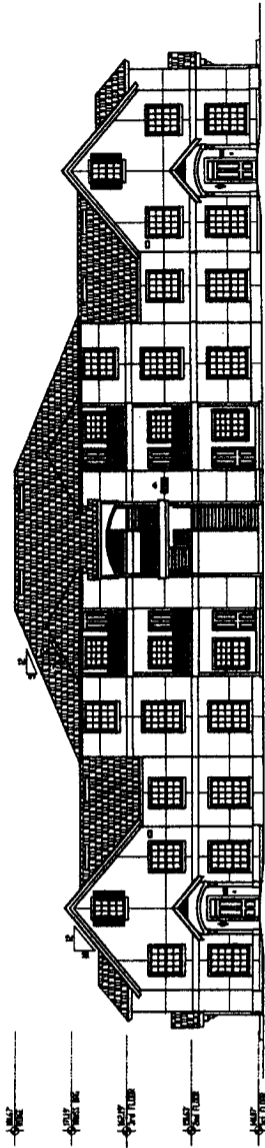

BUILDING 20 - FRONT ELEVATION

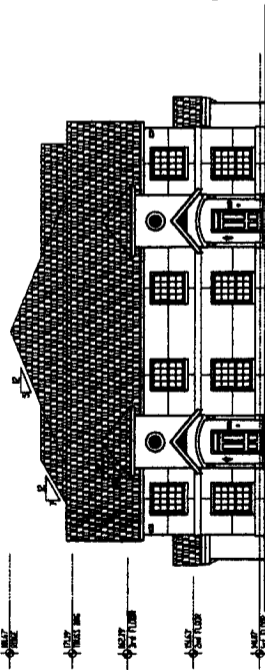

BUILDING 20 - SIDE ELEVATION

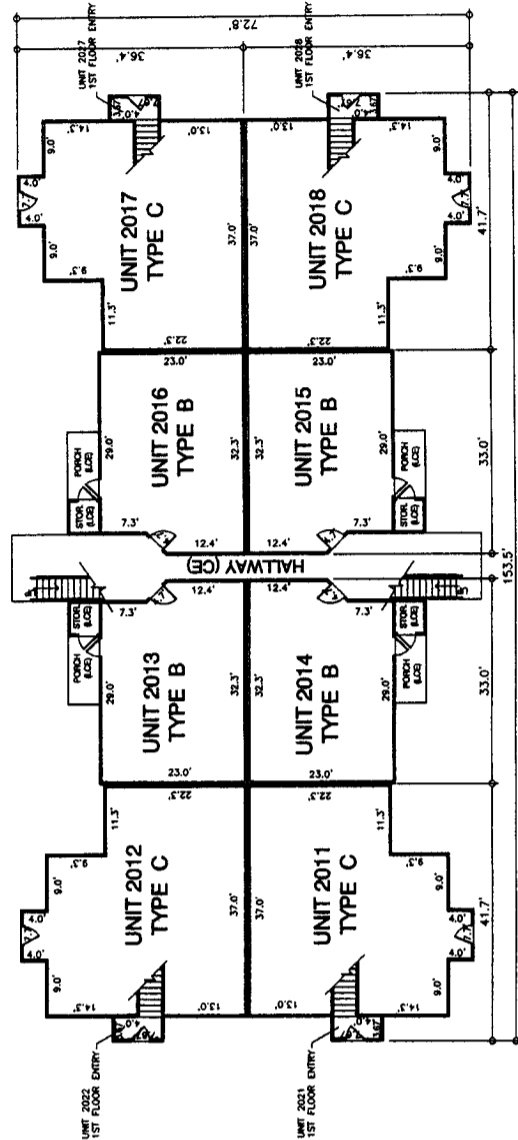

1ST FLOOR

**LEGEND:**  
 COMMON ELEMENT  
 UNIT COMMON ELEMENT  
 LEE  
 STOR.  
 STORAGE

**NOTES:**  
 ALL DIMENSIONS ARE APPROXIMATED.  
 ALL STORAGE AND PORCHES ARE LIMITED COMMON ELEMENTS.  
 EACH GARAGE IS A COMMON ELEMENT UNTIL ASSIGNED TO A PARTICULAR UNIT, AT WHICH TIME THE GARAGE BECOMES A LIMITED COMMON ELEMENT OF THE UNIT TO WHICH IT IS ASSIGNED.  
 ALL IMPROVEMENTS OUTSIDE OF THE UNITS AND NOT LABELED LIMITED COMMON ELEMENTS ARE COMMON ELEMENTS.

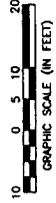

BUILDING 20  
 FLOOR PLANS & ELEVATIONS  
 SHEET 25 OF 33

LAND SURVEYING DIVISION OF  
**John B. Webb & Associates, Inc.**  
 CIVIL & ENVIRONMENTAL CONSULTING ENGINEERS  
 925 S. DEWING DRIVE  
 WINTER PARK, FLORIDA 32789  
 TEL: (407) 947-8888 FAX: (407) 947-9325  
 EMAIL: WEBB@WBAJ.COM

**THE FOUNTAINS AT METRO WEST, A CONDOMINIUM**

A CONDOMINIUM LYING IN SECTION 36, TOWNSHIP 22 SOUTH, RANGE 28 EAST, ORANGE COUNTY, FLORIDA

EXHIBIT 2\* TO DECLARATION OF CONDOMINIUM

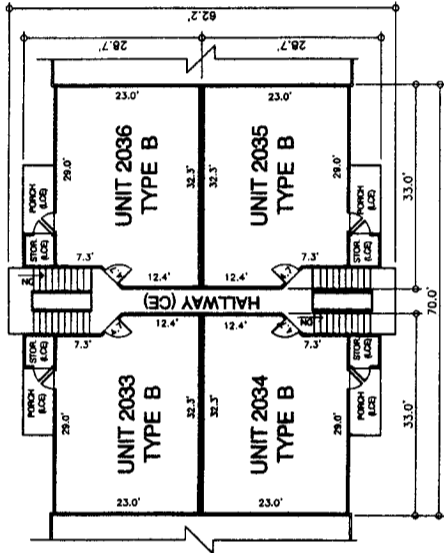

3RD FLOOR

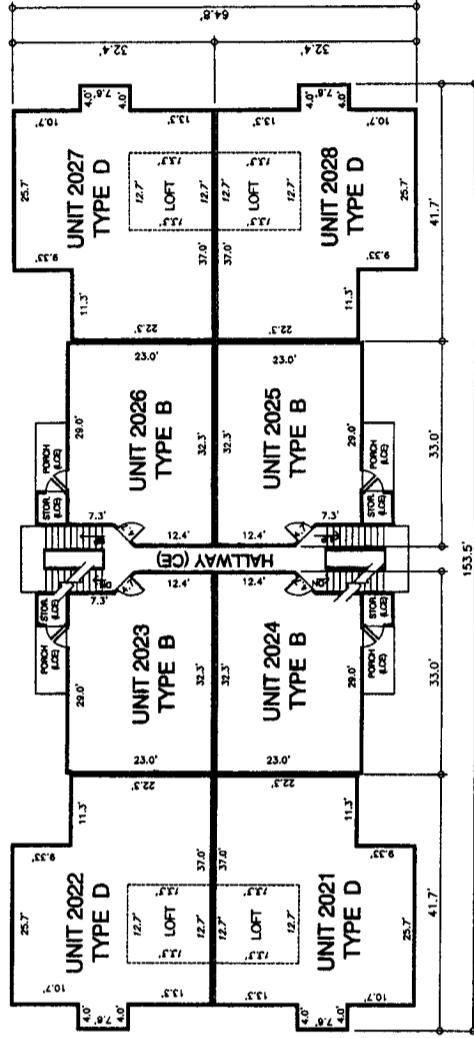

2ND FLOOR

LEGEND:  
 CE COMMON ELEMENT  
 L23 LIMITED COMMON ELEMENT  
 STOR. STORAGE

NOTES:  
 ALL DIMENSIONS ARE APPROXIMATED.  
 ALL TERRACE AND PORCHES ARE LIMITED COMMON ELEMENTS.  
 EACH GARAGE IS A COMMON ELEMENT UNTIL ASSIGNED TO A PARTICULAR UNIT, AT WHICH TIME THE GARAGE BECOMES A LIMITED COMMON ELEMENT OF THE UNIT TO WHICH IT IS ASSIGNED.  
 ALL IMPROVEMENTS OUTSIDE OF THE UNITS AND NOT LABELED LIMITED COMMON ELEMENTS ARE COMMON ELEMENTS.



**BUILDING 20**  
**FLOOR PLANS**  
 SHEET 26 OF 33

LAND SURVEYING DIVISION OF  
**John R. Webb & Associates, Inc.**  
 CIVIL & ENVIRONMENTAL CONSULTING ENGINEERS  
 1000 W. UNIVERSITY BLVD., SUITE 100  
 100 S. BEAUMONT DRIVE  
 AUSTIN, TEXAS 78705  
 PH: (407) 432-4322 FAX: (407) 822-9325  
 EMAIL: WEBB@WEBBINC.COM

# THE FOUNTAINS AT METRO WEST, A CONDOMINIUM

A CONDOMINIUM LYING IN SECTION 36, TOWNSHIP 22 SOUTH, RANGE 28 EAST, ORANGE COUNTY, FLORIDA

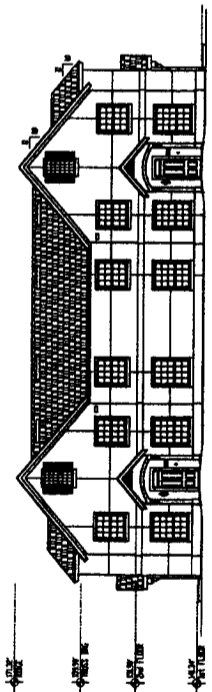

BUILDING 21 - FRONT ELEVATION

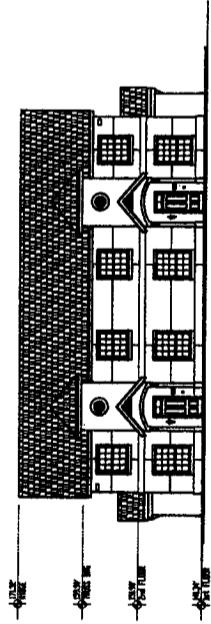

BUILDING 21 - SIDE ELEVATION

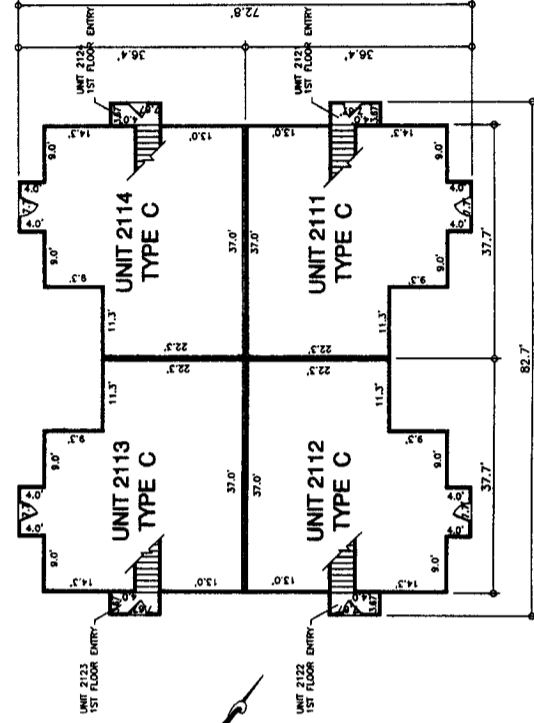
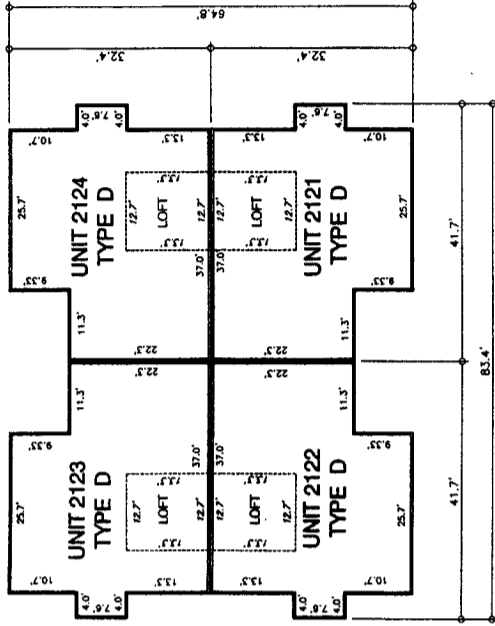

LEGEND:  
 CE COMMON ELEMENT  
 LCE LIMITED COMMON ELEMENT  
 STOR. STORAGE

NOTES:  
 ALL DIMENSIONS ARE APPROXIMATED.  
 ALL STORAGE AND PORCHES ARE LIMITED COMMON ELEMENTS.  
 EACH GARAGE IS A COMMON ELEMENT UNLESS ASSIGNED TO A PARTICULAR UNIT.  
 UNITS ARE ASSIGNED TO THE LIMITED COMMON ELEMENT OF THE UNIT TO WHICH IT IS ASSIGNED.  
 ALL IMPROVEMENTS OUTSIDE OF THE UNITS AND NOT LABELED LIMITED COMMON ELEMENTS ARE COMMON ELEMENTS.

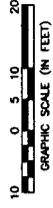

LANS SURVEYING DIVISION OF  
**John R. Webb & Associates, Inc.**  
 CIVIL & ENVIRONMENTAL CONSULTING ENGINEERS  
 1025 S. DENNING DRIVE  
 WINTER HAVEN, FLORIDA 33884  
 PH: (407) 822-4322 FAX: (407) 822-9325  
 EMAIL: WEBB@WEBB.AOL.COM

# THE FOUNTAINS AT METRO WEST, A CONDOMINIUM

A CONDOMINIUM LYING IN SECTION 36, TOWNSHIP 22 SOUTH, RANGE 28 EAST, ORANGE COUNTY, FLORIDA

CONDOMINIUM BOOK PAGE

EXHIBIT 2\* TO DECLARATION OF CONDOMINIUM

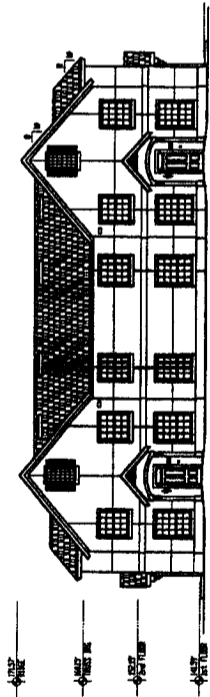

BUILDING 22 - FRONT ELEVATION

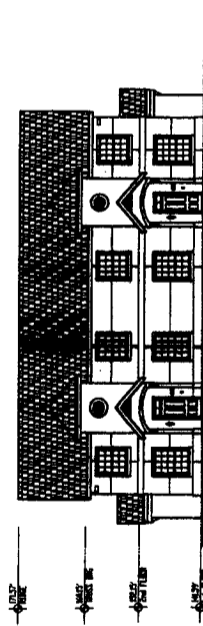

BUILDING 22 - SIDE ELEVATION

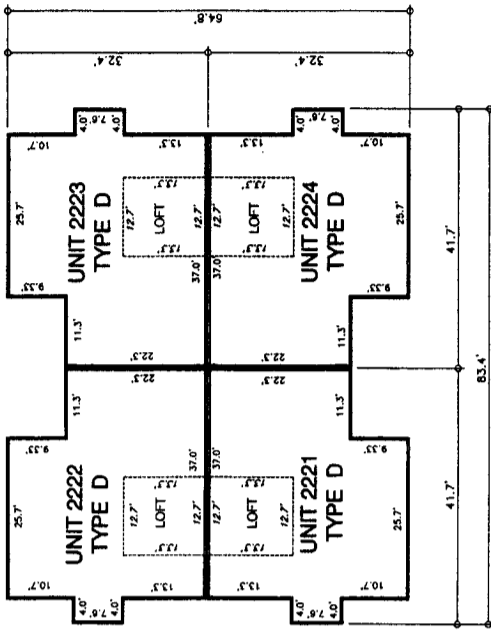

2ND FLOOR

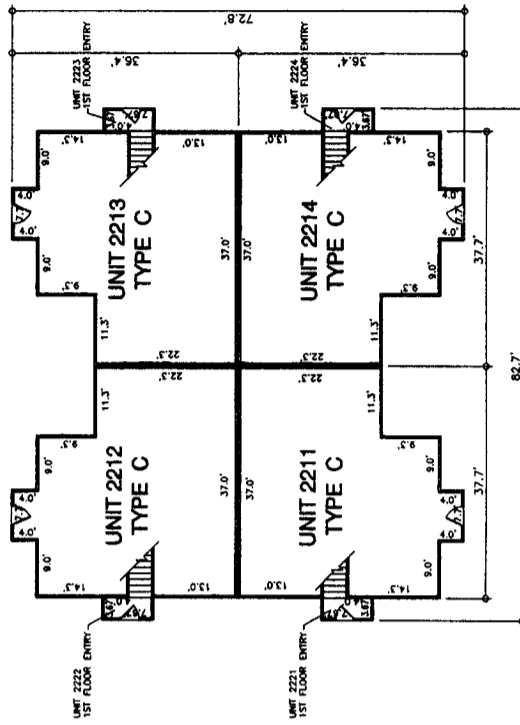

1ST FLOOR

LEGEND:  
 CE COMMON ELEMENT  
 STOR. STORAGE  
 CE COMMON ELEMENT  
 STOR. STORAGE

NOTES:  
 ALL DIMENSIONS ARE APPROXIMATED.  
 ALL STORAGE AND FINISHES ARE LIMITED COMMON ELEMENTS.  
 EACH GARAGE IS A COMMON ELEMENT UNIT. ASSIGNED TO A PARTICULAR UNIT, AT WHICH TIME THE GARAGE BECOMES A LIMITED COMMON ELEMENT OF THE UNIT TO WHICH IT IS ASSIGNED.  
 ALL IMPROVEMENTS OUTSIDE OF THE UNITS AND NOT LABELED LIMITED COMMON ELEMENTS ARE COMMON ELEMENTS.

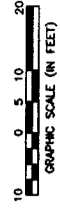

BUILDING 22  
 FLOOR PLANS & ELEVATIONS  
 SHEET 28 OF 33

LAW & SURVEYING DIVISION OF  
**John R. Webb & Associates, Inc.**  
 CIVIL & ENVIRONMENTAL CONSULTING ENGINEERS  
 825 S. DENNING DRIVE  
 WINTER PARK, FLORIDA 32789  
 PH: (407) 622-8322 FAX: (407) 622-8325  
 EMAIL: WEBBENG@AOL.COM

# THE FOUNTAINS AT METRO WEST, A CONDOMINIUM

A CONDOMINIUM LYING IN SECTION 36, TOWNSHIP 22 SOUTH, RANGE 28 EAST, ORANGE COUNTY, FLORIDA

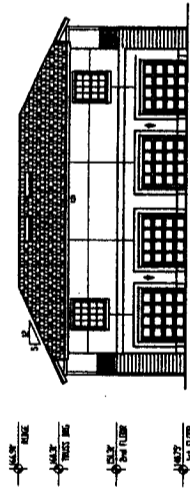

BUILDING 23 - FRONT ELEVATION

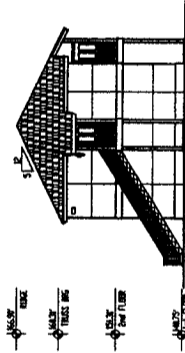

BUILDING 23 - SIDE ELEVATION

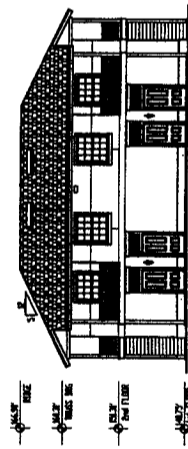

BUILDING 23 - REAR ELEVATION

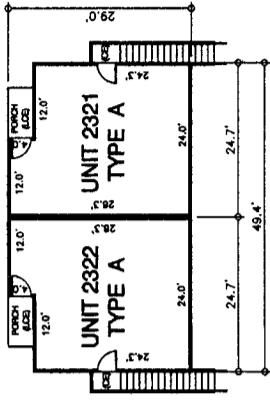

2ND FLOOR

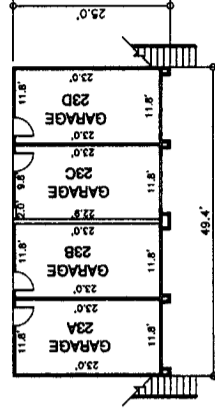

1ST FLOOR

LEGEND:  
 CE COMMON ELEMENT  
 LCE LIMITED COMMON ELEMENT  
 STOR. STORAGE

NOTES:  
 ALL DIMENSIONS ARE APPROXIMATED.  
 ALL STORAGE AND PORCHES ARE LIMITED COMMON ELEMENTS.

EACH GARAGE IS A COMMON ELEMENT AT WHICH TIME THE GARAGE BECOMES A LIMITED COMMON ELEMENT OF THE UNIT TO WHICH IT IS ASSIGNED.  
 ALL UNASSIGNED PORTIONS OF THE COMMON ELEMENTS ARE COMMON ELEMENTS.

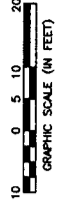

LAND SURVEYING DIVISION OF  
**John B. Webb & Associates, Inc.**  
 CIVIL & ENVIRONMENTAL CONSULTING ENGINEERS  
 WINTER PARK, FLORIDA 32789  
 PH: (407) 822-9322 FAX: (407) 822-9325  
 EMAIL: WEBBER@AOL.COM



# THE FOUNTAINS AT METRO WEST, A CONDOMINIUM

A CONDOMINIUM LYING IN SECTION 36, TOWNSHIP 22 SOUTH, RANGE 28 EAST, ORANGE COUNTY, FLORIDA

CONDOMINIUM BOOK PAGE

EXHIBIT 2\* TO DECLARATION OF CONDOMINIUM

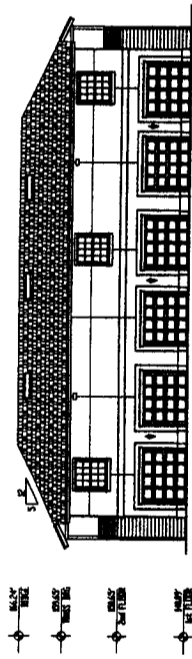

BUILDING 24 - FRONT ELEVATION

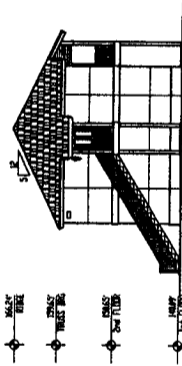

BUILDING 24 - SIDE ELEVATION

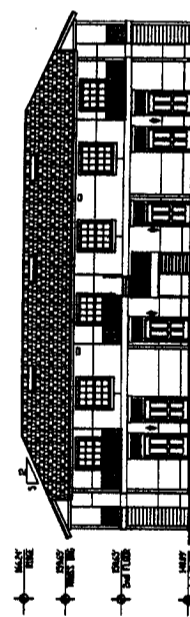

BUILDING 24 - REAR ELEVATION

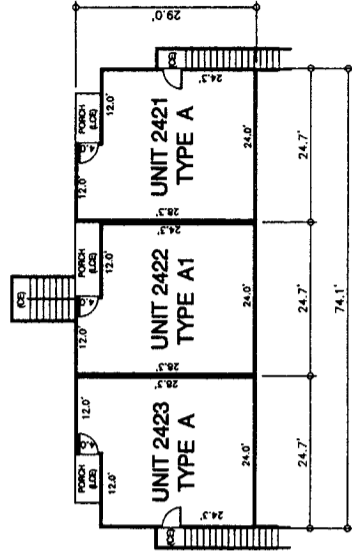

2ND FLOOR

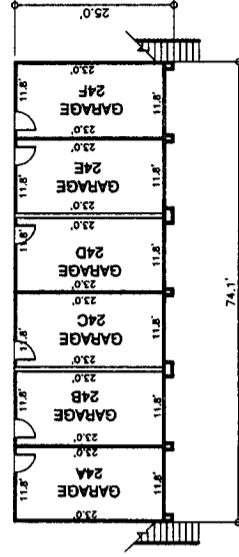

1ST FLOOR

LEGEND:  
 CE COMMON ELEMENT  
 LE LIMITED COMMON ELEMENT  
 STOR. STORAGE

NOTES:  
 ALL DIMENSIONS ARE APPROXIMATED.  
 ALL STORAGE AND PORCHES ARE LIMITED COMMON ELEMENTS.

EACH GARAGE IS A COMMON ELEMENT. AT ANY TIME THE GARAGE BECOMES A LIMITED COMMON ELEMENT OF THE UNIT TO WHICH IT IS ASSIGNED.  
 ALL IMPROVEMENTS OUTSIDE OF THE COMMON ELEMENTS ARE COMMON ELEMENTS.



BUILDING 24  
 FLOOR PLANS & ELEVATIONS  
 SHEET 30 OF 33

LAND SURVEYING DIVISION OF  
**John R. Webb & Associates, Inc.**  
 CIVIL & ENVIRONMENTAL CONSULTING ENGINEERS  
 1000 UNIVERSITY AVENUE  
 WINTER PARK, FLORIDA 32789  
 P.O. BOX 1000  
 PHONE: (407) 622-4322 FAX: (407) 622-4325  
 EMAIL: WEBB@RRWV.COM

# THE FOUNTAINS AT METRO WEST, A CONDOMINIUM

A CONDOMINIUM LYING IN SECTION 36, TOWNSHIP 22 SOUTH, RANGE 28 EAST, ORANGE COUNTY, FLORIDA

EXHIBIT "2" TO DECLARATION OF CONDOMINIUM

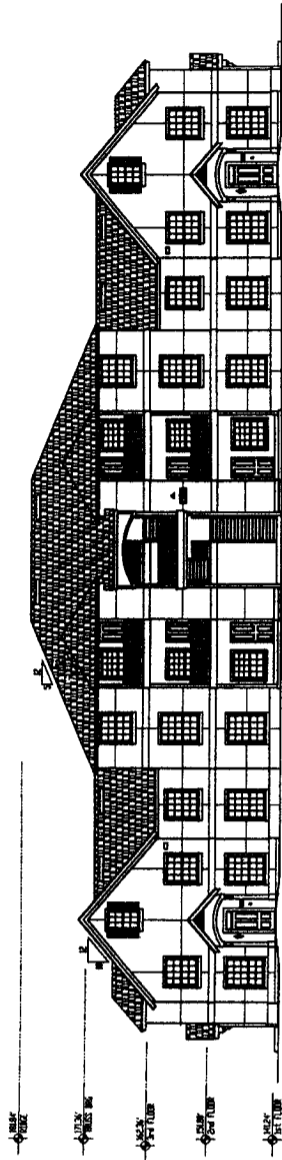

BUILDING 25 - FRONT ELEVATION

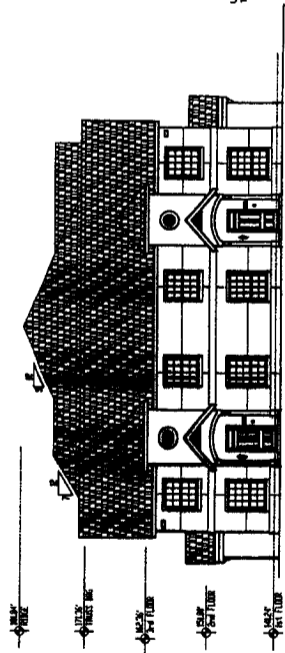

BUILDING 25 - SIDE ELEVATION

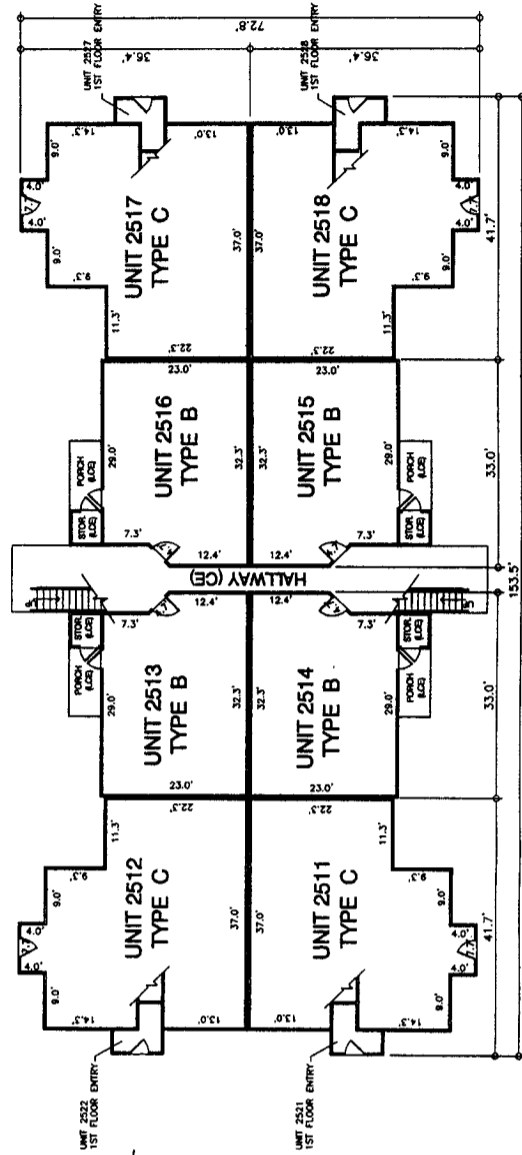

1ST FLOOR

LEGEND:  
 CE COMMON ELEMENT  
 STOR. STORAGE  
 CE COMMON ELEMENT  
 CE COMMON ELEMENT  
 STOR. STORAGE

NOTES:  
 ALL DIMENSIONS ARE APPROXIMATED.  
 ALL STORAGE AND PORCHES ARE LIMITED COMMON ELEMENTS.  
 EACH GARAGE IS A COMMON ELEMENT AND IS TO BE USED ONLY AT WHICH TIME THE GARAGE BECOMES A LIMITED COMMON ELEMENT OF THE UNIT TO WHICH IT IS ASSIGNED.  
 ALL IMPROVEMENTS OUTSIDE OF THE UNIT ARE TO BE CONSIDERED LIMITED COMMON ELEMENTS AND ARE COMMON ELEMENTS.



LAND SURVEYING DIVISION OF  
**John B. Webb & Associates, Inc.**  
 CIVIL & ENVIRONMENTAL CONSULTING ENGINEERS  
 925 S. DEERBROOK DRIVE  
 WINTER PARK, FLORIDA 32789  
 PH: (407) 832-8322 FAX: (407) 832-8325  
 EMAIL: WEBB@WEBBINC.COM

# THE FOUNTAINS AT METRO WEST, A CONDOMINIUM

A CONDOMINIUM LYING IN SECTION 36, TOWNSHIP 22 SOUTH, RANGE 28 EAST, ORANGE COUNTY, FLORIDA

CONDOMINIUM BOOK PAGE

EXHIBIT 2' TO DECLARATION OF CONDOMINIUM

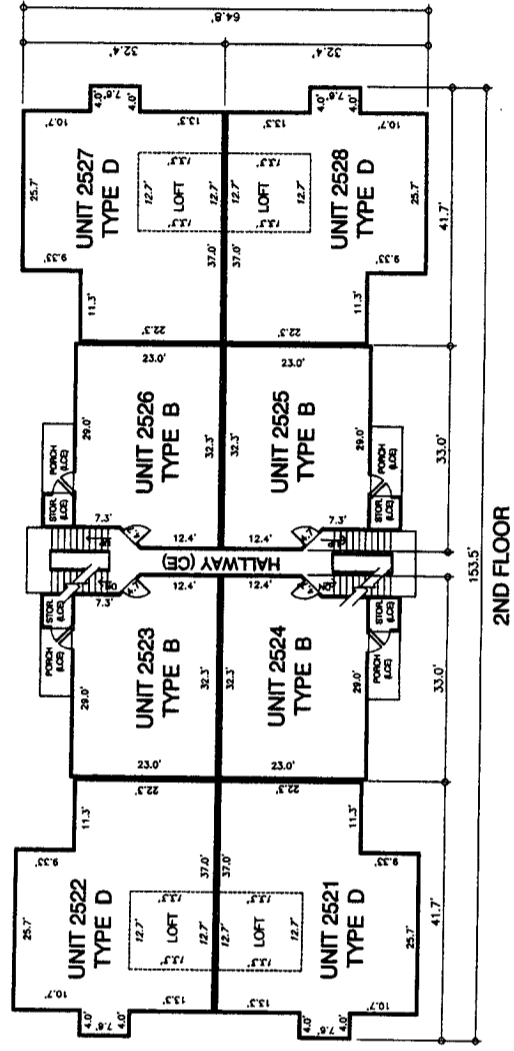
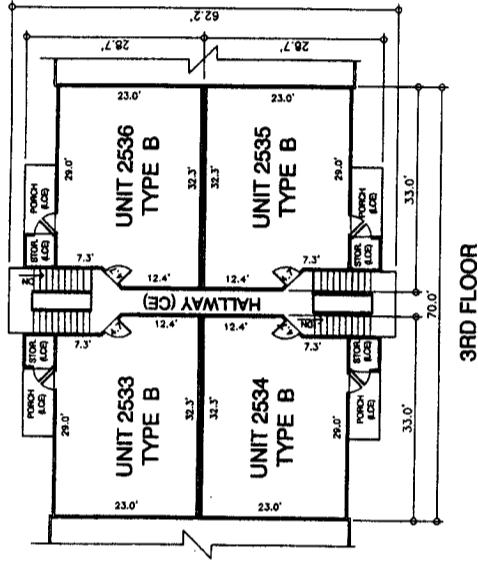

**LEGEND:**  
 CE COMMON ELEMENT  
 LCE LIMITED COMMON ELEMENT  
 STOR. STORAGE

**NOTES:**  
 ALL DIMENSIONS ARE APPROXIMATED.  
 ALL STORAGE AND PORCHES ARE LIMITED COMMON ELEMENTS.  
 EACH GARAGE IS A COMMON ELEMENT AND IS ASSIGNED TO THE UNIT AT WHICH THE GARAGE IS LOCATED. LIMITED COMMON ELEMENTS ARE THOSE LIMITED COMMON ELEMENTS OF THE UNIT TO WHICH IT IS ASSIGNED.  
 ALL IMPROVEMENTS OUTSIDE OF THE UNIT ARE LIMITED COMMON ELEMENTS. COMMON ELEMENTS ARE COMMON ELEMENTS.

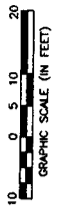

**BUILDING 25**  
**FLOOR PLANS**  
 SHEET 32 OF 33

LAND SURVEYING DIVISION OF  
**John R. Webb & Associates, Inc.**  
 CIVIL & ENVIRONMENTAL CONSULTING ENGINEERS  
 125 S. DENNING DRIVE  
 WINTER HAVEN, FL 33880  
 PH: (407) 822-4322 FAX: (407) 822-9325  
 EMAIL: WEBBER@WAGL.COM

# THE FOUNTAINS AT METRO WEST, A CONDOMINIUM

A CONDOMINIUM LYING IN SECTION 36, TOWNSHIP 22 SOUTH, RANGE 28 EAST, ORANGE COUNTY, FLORIDA

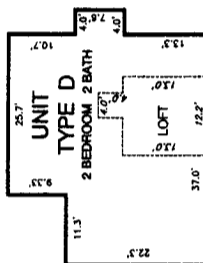
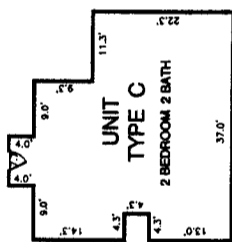
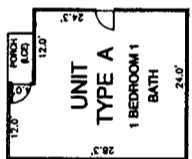
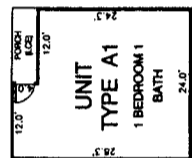
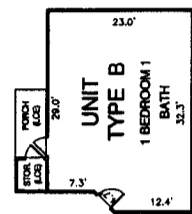

1ST FLOOR ENTRY TO UNIT D

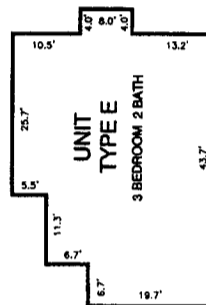
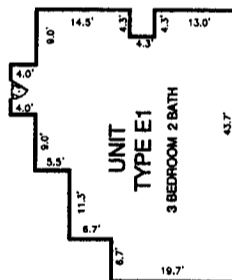

1ST FLOOR ENTRY TO UNIT E

LEGEND:  
 CE COMMON ELEMENT  
 LCE LIMITED COMMON ELEMENT  
 STOR. STORAGE

NOTES:  
 ALL DIMENSIONS ARE APPROXIMATED.  
 ALL STORAGE AND PORCHES ARE LIMITED COMMON ELEMENTS.  
 EACH CHANGE IS A COMMON ELEMENT UNTIL ASSIGNED TO A PARTICULAR UNIT, AT WHICH TIME THE CHANGE BECOMES A LIMITED COMMON ELEMENT OF THE UNIT TO WHICH IT IS ASSIGNED.  
 ALL IMPROVEMENTS OUTSIDE OF THE UNITS AND NOT LABELED LIMITED COMMON ELEMENTS ARE COMMON ELEMENTS.

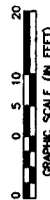

LAND SURVEYING DIVISION OF  
**John H. Webb & Associates, Inc.**  
 CIVIL & ENVIRONMENTAL CONSULTING ENGINEERS  
 105 S. UNIVERSITY AVENUE  
 WINTER PARK, FLORIDA 32789  
 PH: (407) 822-4322 FAX: (407) 822-8325  
 EMAIL: WEBBENGINEERING.COM